

PowerShield®

PrimusCharge 3000 Uninterruptible Power Station (UPS)

PrimusCharge Battery Bank (optional)

USER MANUAL



TABLE OF CONTENTS

1. Safety and emc Instructions.....	5
1-1. Transportation and Storage	5
1-2. Preparation	5
1-3. Installation.....	5
1-4. Connection Warnings.....	5
1-5. Before Working on this Circuit.....	6
1-6. General Warnings	6
1-7. Operation.....	6
2. Introduction And Setup.....	7
2-1. Basic System Architecture	7
3. Product Overview	8
3-1. Main Unit.....	8
3-2. External Battery Module (Purchased separately).....	9
4. Installation.....	10
4.1. Package Contents	10
4-2. Internal Battery Connection	11
4-3. AC Input Connection.....	11
4-4. PV Connection	12
4-5. AC Output Connection	13
4-6. USB Charger.....	13
4-7. Parallel Function	14
5. Operation	19
5-1. Power ON/OFF	19
5-2. Operation and Display Panel.....	19
5-3. Page Information	20
5-4. Configurations	21
5-5. Wi-Fi Connection	22
5-6. Prioritising Energies Scenarios	23
6. Storage and Maintenance.....	26
6-1. Storage	26
6-2. Maintenance	26
7. Runtime Table	27
8. Troubleshooting.....	27
8-1. Warning and Fault List.....	27
9. Appendix I: The Wi-Fi Operation Guide	29
10. Specifications – PrimusCharge 3000.....	39
11. Specifications – PrimusCharge Battery Bank	40

ABOUT THIS MANUAL

WARNING

Before energising the PrimusCharge 3000, please take the time to read and understand:

- all of the safety information
- all of the warnings
- all of the operating instructions

It is highly recommended to have the PrimusCharge 3000 commissioned by a Powershield Service Partner. This equipment should only be serviced and maintained by qualified PowerShield Service Partners. Failure to use a qualified service partner may impact your warranty.

All electrical works must be undertaken by qualified electricians. If the solar input is used, only solar qualified personnel may undertake works associated with the solar array.

This product is not designed for outdoor use.

Disclaimer: We assume no responsibility or liability for loss or damages, whether direct, indirect, consequential or incidental, which might arise out of the use of this manual. Information in this manual is subject to change without notice. If you find information in this manual that is incorrect, misleading, or incomplete, we would appreciate your comments and suggestions.

1. SAFETY AND EMC INSTRUCTIONS

All safety instructions in this document must be read, understood, and followed.

1.1 Transportation and Storage

- Please transport the UPS system only in the original packaging to protect against shock and damage.
- The UPS must be stored in a facility where the temperature is well regulated. Ambient temperatures should be between 0–40°C and relative humidity shall be 0–95% non-condensing.
- Any storage of greater than 90 days refer to section 6 for more detail.

1.2 Preparation

- Condensation may form if the UPS system is moved immediately from cold to warm environment. The UPS system must be dry before being installed. Please allow at least two hours for the UPS system to acclimatise to the environment prior to energisation.
- If the UPS might be exposed to temperatures over 40°C, please contact PowerShield for further advise.
- Do not install the UPS where the relative humidity exceeds 95%, and non-condensing.
- Do not install outdoors, this is an indoor product only.
- Do not install the UPS near bodies of water or salt water.
- Do not install the UPS in high dust, conductive dust environments
- Do not install the UPS system where it would be exposed to direct sunlight or nearby heat source.
- Do not block ventilation holes on the UPS housing.

1.3 Installation

- Do not connect appliances or devices which would overload the UPS. Care needs to be taken with motor start loads, or other load with high inrush to size the UPS accordingly.
- The UPS requires 30cm front and rear access for maintenance and airflow.
- The UPS and any supplied battery cabinets come with an earth connection. Please ensure all earth connections are installed and tested in accordance with AS/NZS 3000 and or local regulations.
- All electrical work shall be undertaken by a qualified electrician (in your local jurisdiction)
- All commissioning / start-up shall be undertaken by either PowerShield or a locally trained service technician.
- All ongoing maintenance shall be undertaken by qualified personal. PowerShield recommends that all maintenance work is undertaken by a PowerShield trained service technician, to ensure that the vendor warranty is maintained.
- All cabling, breakers, isolators and the like shall be sized and installed in accordance with this manual and AS/NZS 3000 (suite of standards) or local equivalent, to protect both upstream and downstream of this UPS.

All cabling prior to energisation shall be tested in accordance with AS/NZS 3000 or local equivalent, the test result shall be made available to PowerShield or PowerShield service agent upon request.

1.4 Connection Warnings

- This UPS should be connected with TN grounding/earthing system.
- The power input for this unit must be in accordance with the equipment nameplate. It also must be suitably grounded.
- Secure the grounding/earthing wire before connecting to any live wire terminal.

1.5 Before Working on this Circuit

- Isolate Uninterruptible Power Supply (UPS)
- Isolate the batteries (internal or external)
- Isolate the PV
- Then check for Hazardous Voltage between all terminals including the protected earth
- RISK OF HIGH VOLTAGE

1.6 General Warnings

- The use of this equipment in medical instruments or life-sustaining devices is not recommended if its failure could reasonably be expected to cause the failure of the life-sustaining equipment or significantly impact its safety or effectiveness. Do not use this equipment in the presence of a flammable mixture with air, oxygen or nitrous oxide.
- Connect grounding terminal of UPS to a grounding electrode conductor. The ground conduct should be tested prior to energisation of the UPS.
- Warning labels should be placed on all primary power switches installed in places away from the unit to alert the electrical maintenance personnel of the presence of a UPS in the circuit. The label will bear the following or an equivalent text:

**HAZARD HIGH VOLTAGES PRESENT
MUTLIPE ENERGY SOURCES PRESENT
BEFORE WORKING ON THIS CIRCUIT**

- Isolate Uninterruptible Power Supply (UPS)
- Isolate the batteries (internal or external)
- Isolate the Photo Voltaic Cells (PV)

- Because this inverter is non-isolated, only three types of PV modules are acceptable: single crystalline, poly crystalline with class A-rated and copper indium gallium selenide (CIGS) modules. To avoid any malfunction, do not connect any PV modules with possible current leakage to the inverter. For example, grounded PV modules will cause current leakage to the inverter. When using CIGS modules, please be sure NO grounding.
- It's requested to use PV junction box with surge protection. Otherwise, it will cause damage on inverter when lightning occurs on PV modules.

1.7 Operation

- Do not disconnect the grounding/earthing conductor cable on the UPS or the building wiring terminals under any circumstance.
- The UPS system features its own, current source (batteries). The UPS output terminal blocks may be electrically live even if the UPS system is not connected to the building mains/live cables.
- In order to fully disconnect the UPS system, first press the 'OFF' button, isolate all batteries (internal and/or external) and then disconnect the electrical cabling.
- Ensure that no foreign objects can enter the UPS.
- The UPS should only be operated by individuals that are familiar with operating UPS(s).

2. INTRODUCTION AND SETUP

This is a Plug and Play portable Uninterruptible Power Supply with:

- Pure sine wave inverter
- Built-in BMS communication port
- Dual power source, Solar and Mains
- Lithium batteries
- Ultra Large Charger
- MPPT Solar Charger
- Dust Filter
- Configurable AC/Solar charge priorities
- Overload / Over temperature / short circuit protection
- Option for an additional two (2) external battery modules

This UPS comes with smart charging technologies that allow either solar and or mains power to charge the battery and supply the load.

All units are provided with three (3) A/NZ general purpose power sockets and two (2) USB type-A and two (2) USB type-C charger ports, allowing to power your diverse electronic devices.

2.1 Basic System Architecture

The following illustration shows the basic application for this UPS.

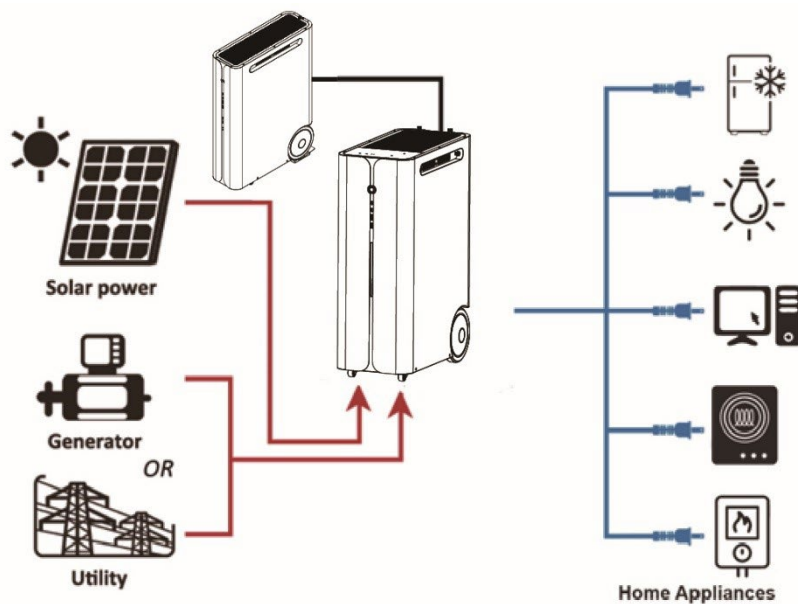

3. PRODUCT OVERVIEW

3.1 Main Unit

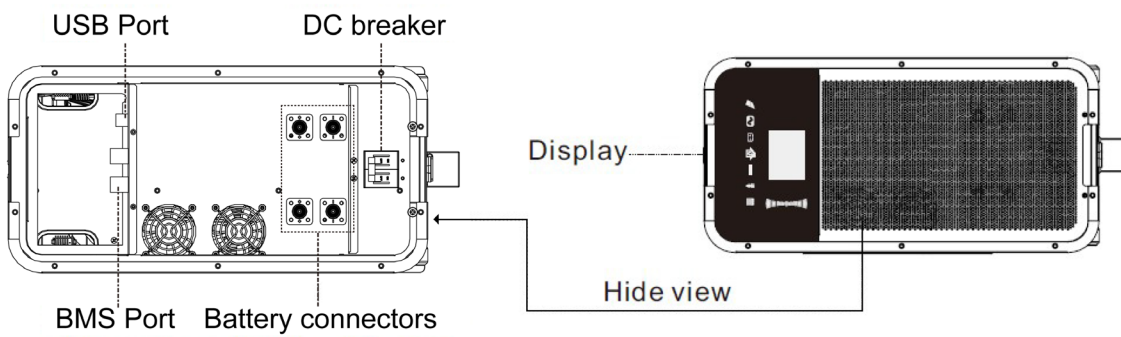
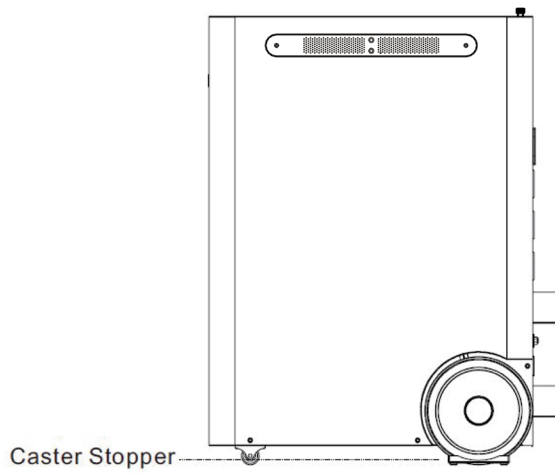
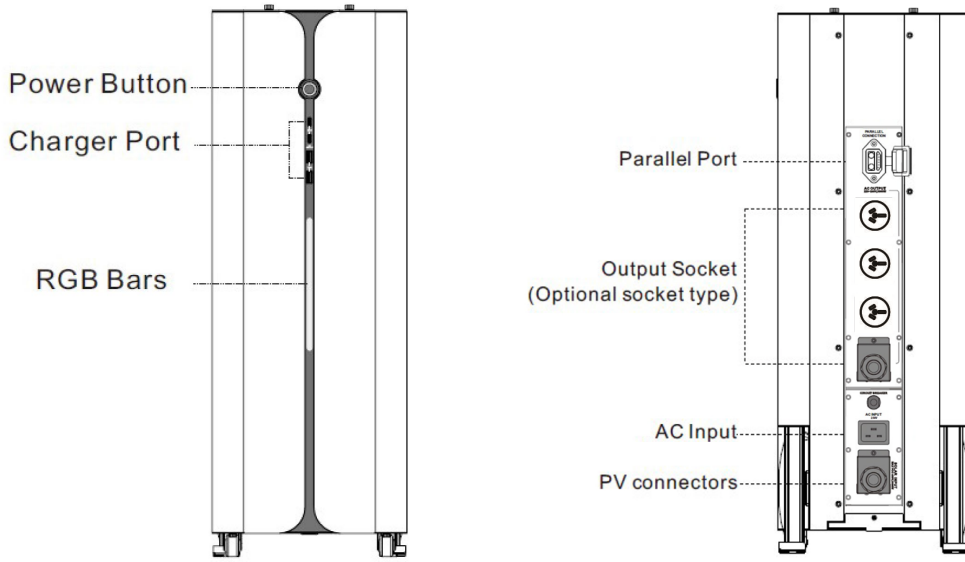



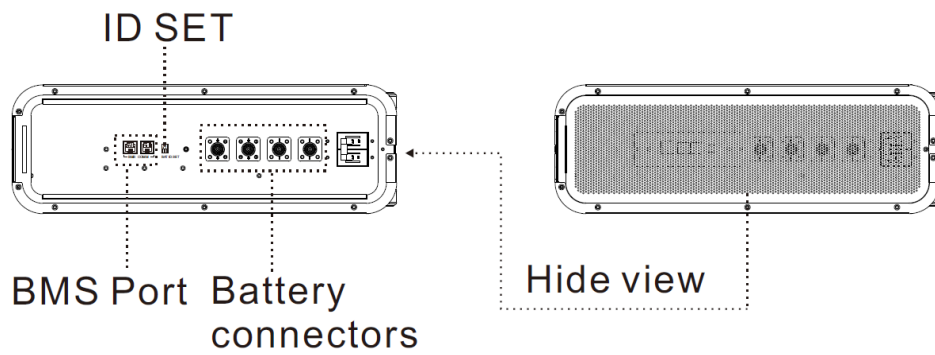
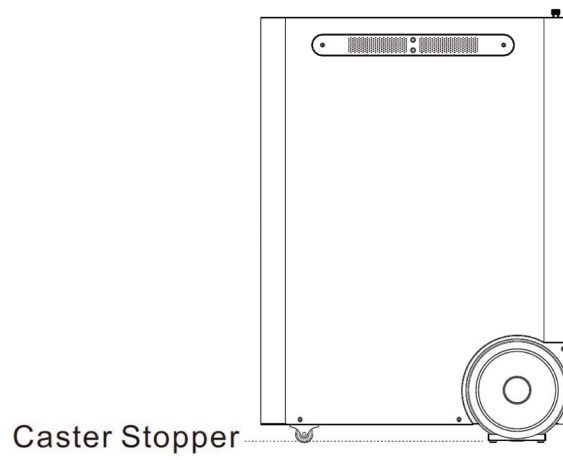
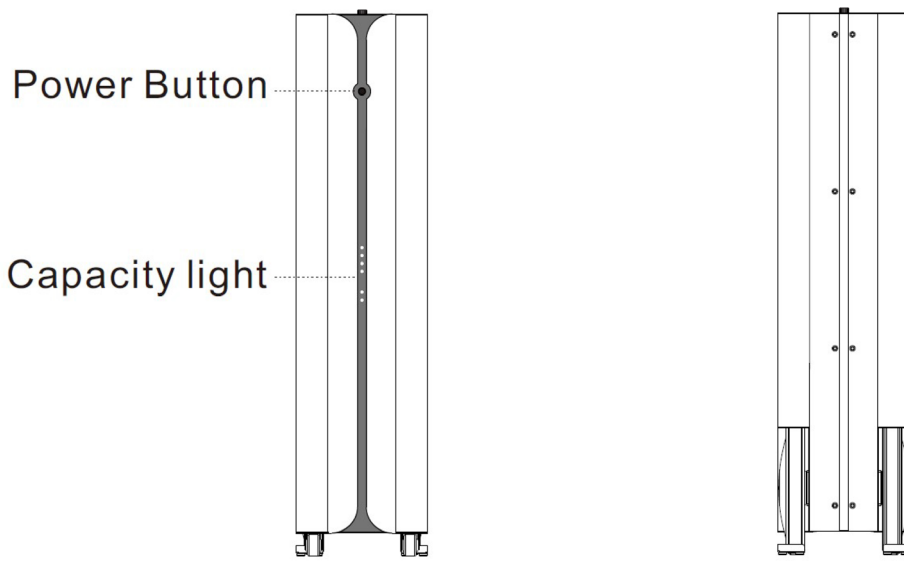

3.2 External Battery Module (Purchased separately)



4. INSTALLATION

4.1 Package Contents

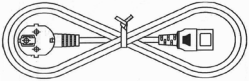
- Unpack the box and check the package contents for the following items:
- One UPS
- One user manual
- One AC power cord
- Two cable glands
- Two castor stoppers

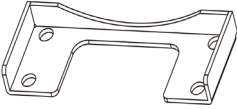
 <p>Inverter with built-in battery</p>	 <p>Manual</p>	 <p>AC power cord</p>
	 <p>Cable Gland x 2</p>	 <p>Caster stopper x 2</p>

NOTE: Please inspect the unit prior to installation. Confirm that there is no physical damage to the unit. Unfortunately, from time-to-time damages occur in transit. If the unit is damaged, please do not install and energise the unit. Please contact PowerShield immediately.

Please keep the original packaging for future use. It is recommended to keep each UPS and battery bank set in their original packaging as they have been designed to provide maximum protection during transportation and storage.



Install the castor stoppers before operation of this UPS.

4.2 Internal Battery Connection

The DC breaker for the internal battery is switched OFF before shipment for safety.

Please remove the two screws from the top panel and switch ON the internal DC breaker before installation. Then re-assemble the panel and replace screws.

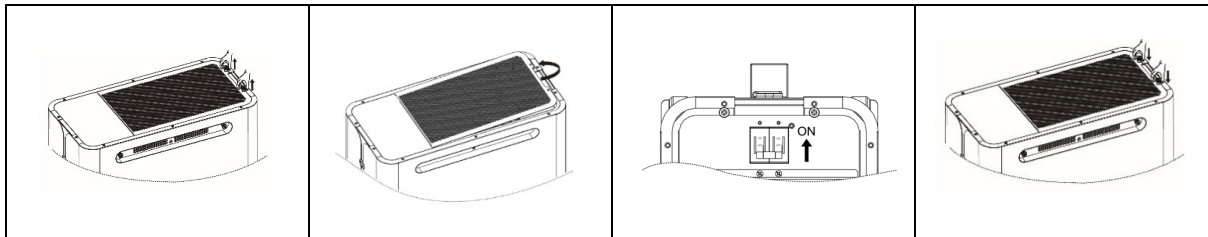

4.3 AC Input Connection

Connect the AC power cord to the IEC Inlet socket and then plug it into the 16 Amp wall socket GPO.

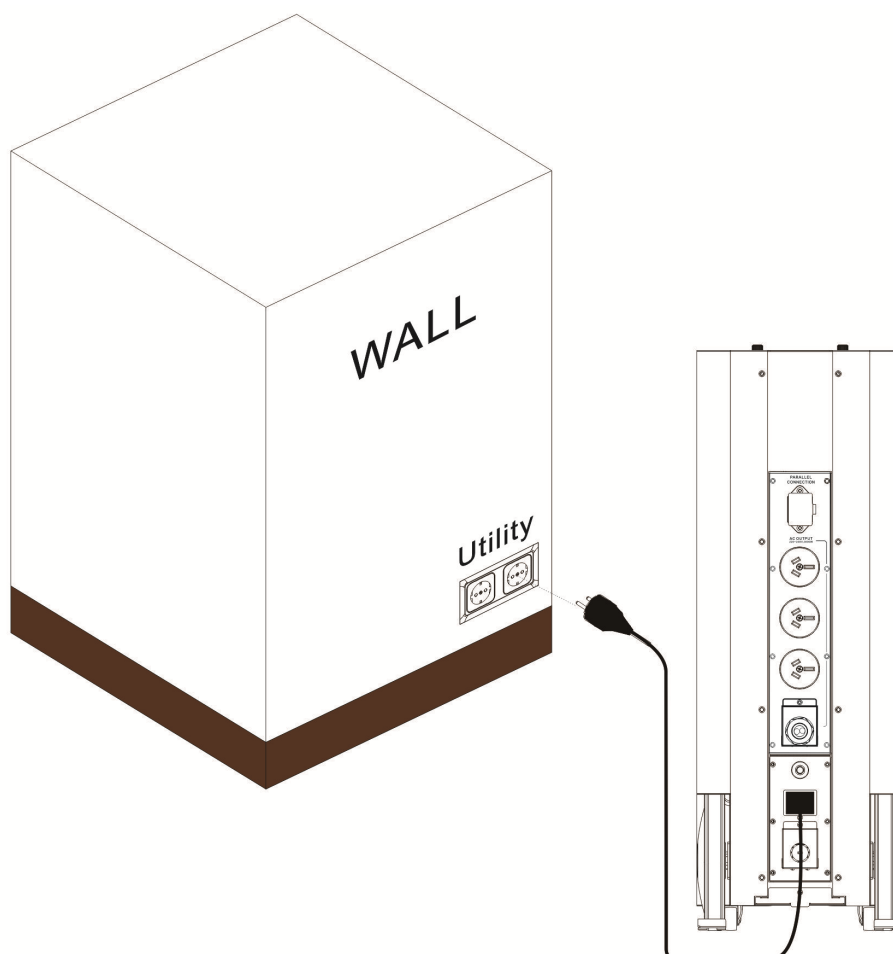

4.4 PV Connection

There are two methods to connect to the PV panels.

1. Connect directly on the terminal block, or
2. Using a pluggable connector.

Direct Terminal Connection

1. Remove the PV connector cover on the rear panel by removing the screws as shown below.
2. Install the cable gland to the connector cover.
3. Install the PV cables on the terminal.
4. Replace cover on the rear panel.

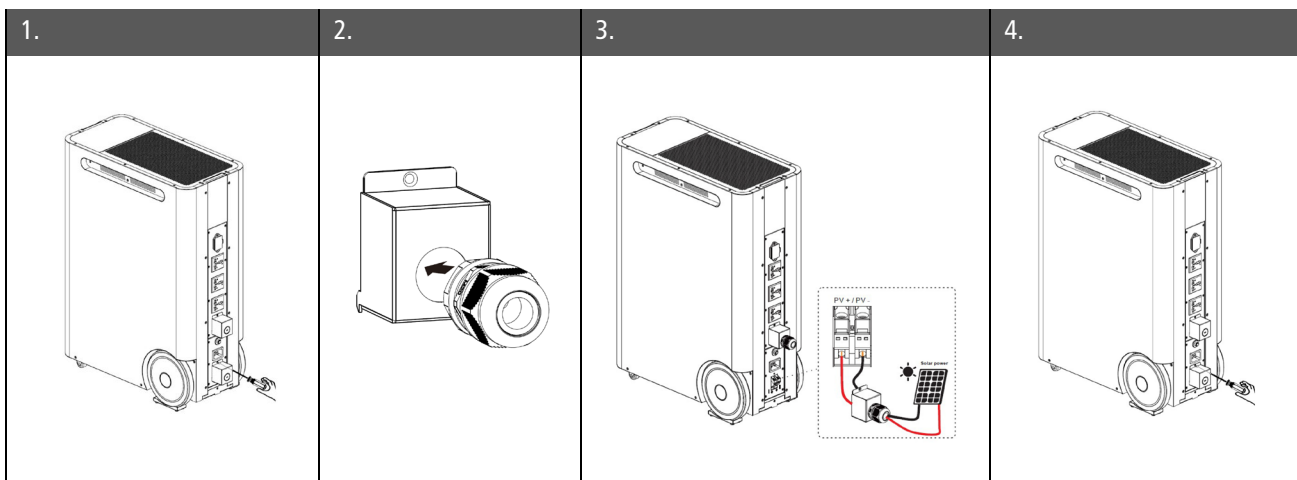

Pluggable Connector Connection

Please follow below steps to implement PV module connection:

1. Remove the PV connector cover on the rear panel by removing the screws as shown below.
2. Install the cable gland to the connector cover.
3. Check correct polarity of cable connection from PV modules and PV input terminals.
4. Connect positive pole (+) of connection cable to positive pole (+) of PV input terminal.
5. Connect negative pole (-) of connection cable to negative pole (-) of PV input terminal.
6. Replace cover on the rear panel.

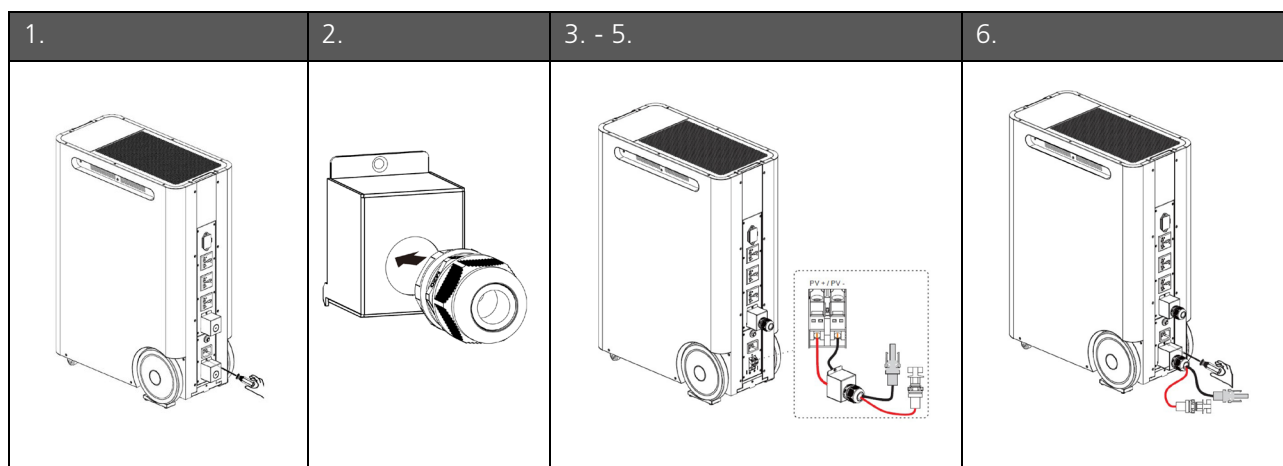

4.5 AC Output Connection

Please ensure the parallel cover is closed when not in use.

Plug AC power cord on the AC output socket.

Press the main switch on the front panel for 3 seconds to turn the UPS ON.

Charge Everything At Once AC Outputs

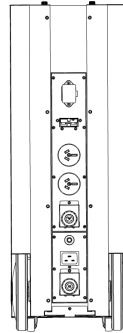
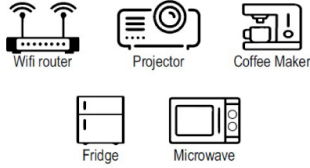

There are three options to supply power to the load.

1. USB Power to USB loads
2. Three 10 Amp outlet sockets on the rear of the unit
3. Hardwired output terminals can supply up to 3kW.

The terminal cover has a \varnothing 20mm knockout plate included. Glands not provided.

CAUTION: Important

Please secure the terminal cover to reduce risk of electric shock

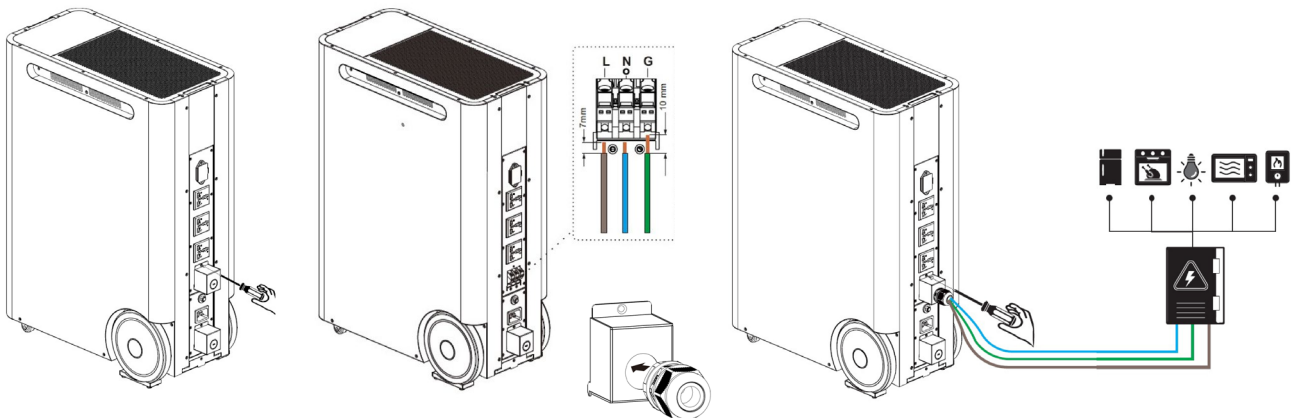

4.6 USB Charger

Use USB output cable (not provided) to charge your electronic devices.

USB charger port can be turned on/off through LCD operation, or through the Wi-Fi App.

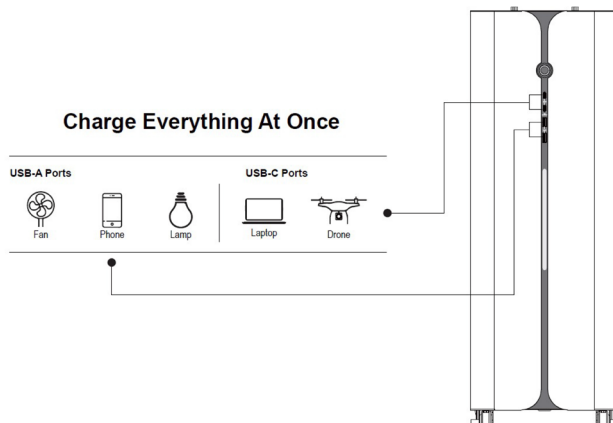

4.7 Parallel Function

4.7.1 Introduction

The PrimusCharge 3000 can be operated in parallel with 2 units. The supported maximum capacity is 6KW. See below for approved configurations of external battery modules.

CAUTION: Parallel feature will be disabled when only PV power is available, and batteries are not available.

4.7.2 System Configuration

There are several configurations available as shown below.

Note: The external battery module is illustrated in grey in the figures below.

Expand Battery Capacity

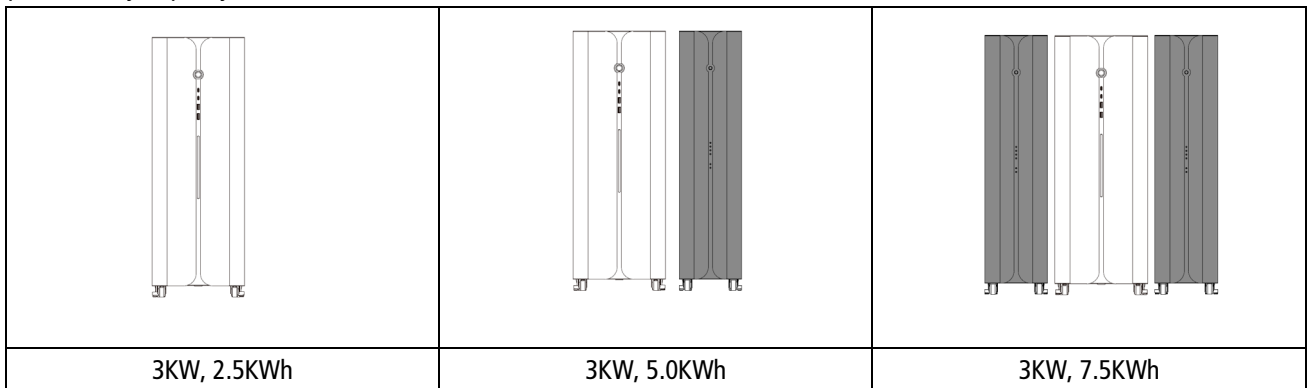

Expand Power and Battery Capacity

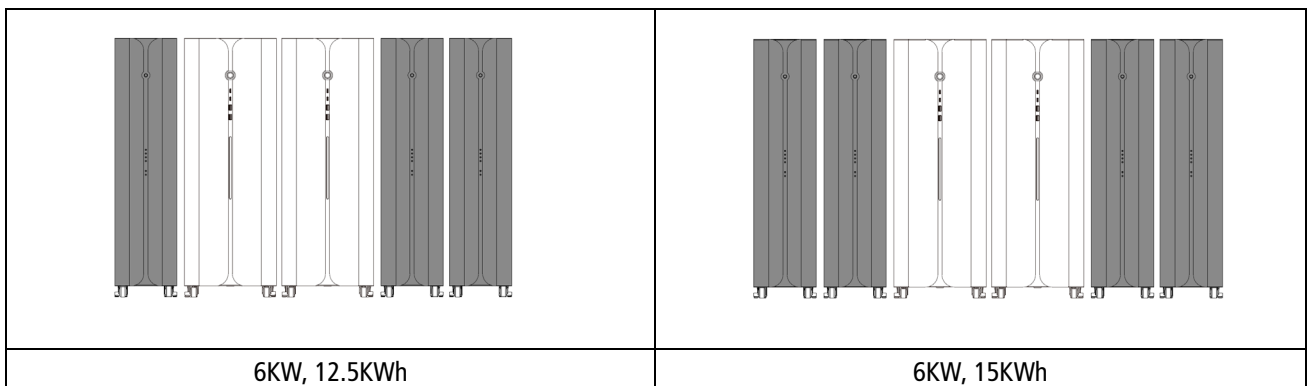
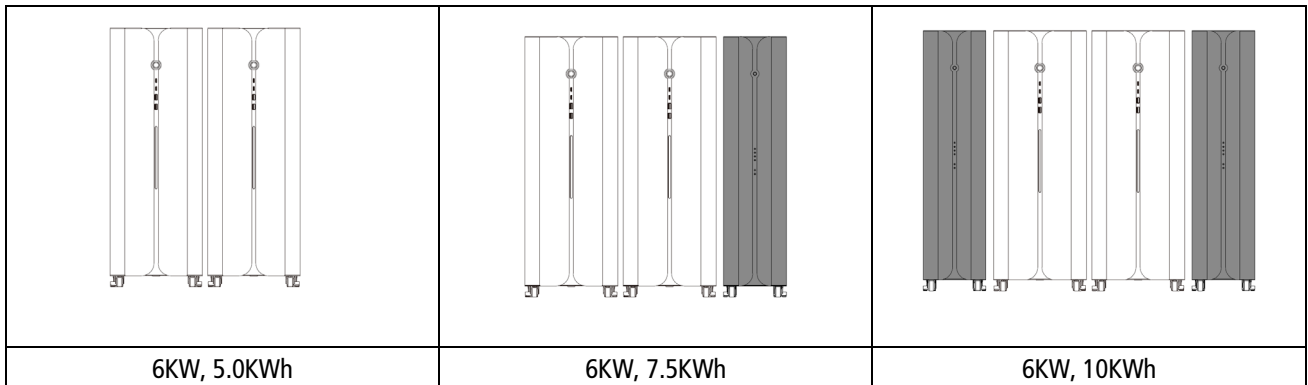

4.7.3 Preparation for adding an External Battery Module.

Before connecting any wires, remove top panel and side cover. Retain side cover for securing the PrimusCharge 3000 Battery Bank to the PrimusCharge 3000.

Refer to below figures for the details.

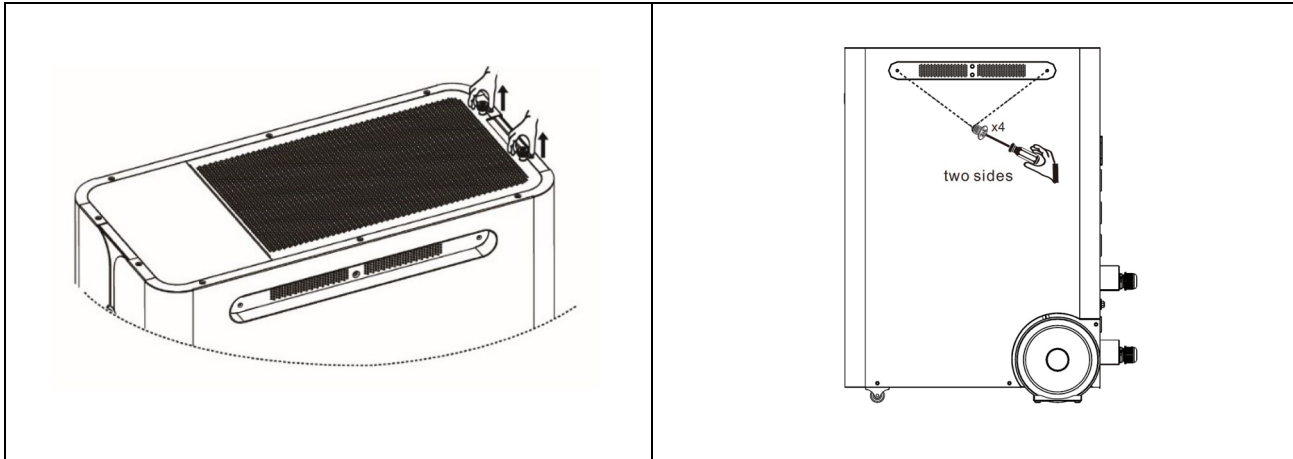

4.7.4 External Battery Connection

A maximum of two external battery modules can be connected.

CAUTION: Disconnect the DC breaker located on the top of the unit before connecting the battery modules.

Step 1: Follow the colour coding of the cabling and the terminals to ensure the correct polarity of the batteries is maintained. Please ensure Earth is also connected.

Expanded Battery Capacity

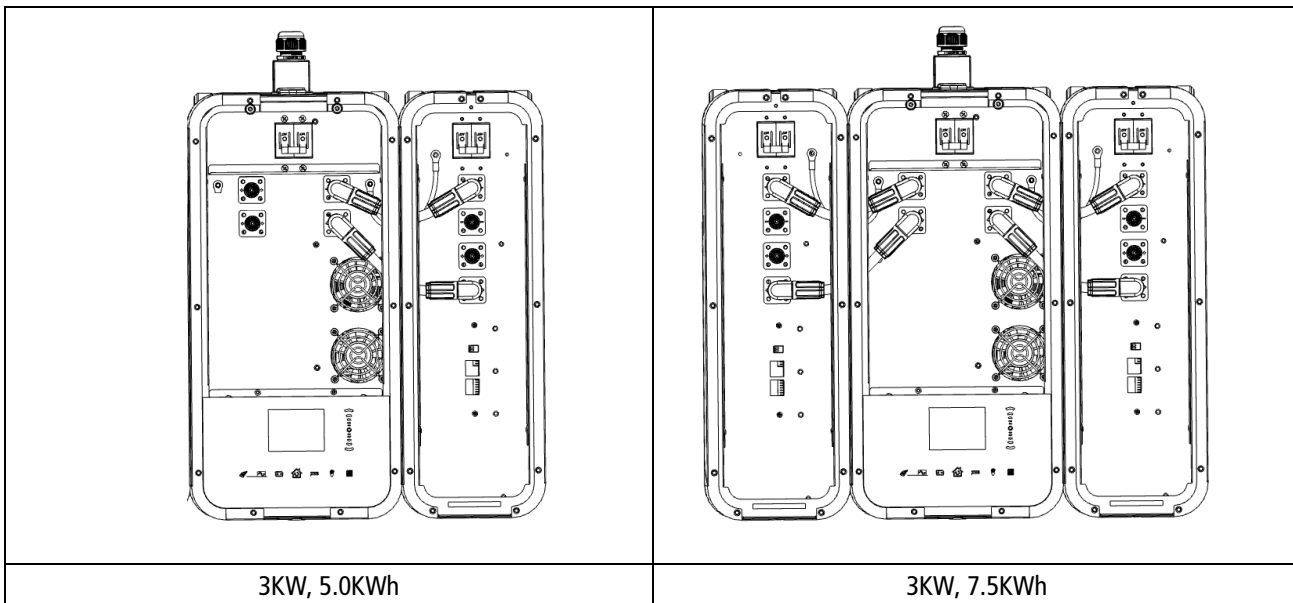

Paralleled UPS and Expanded Battery Capacity

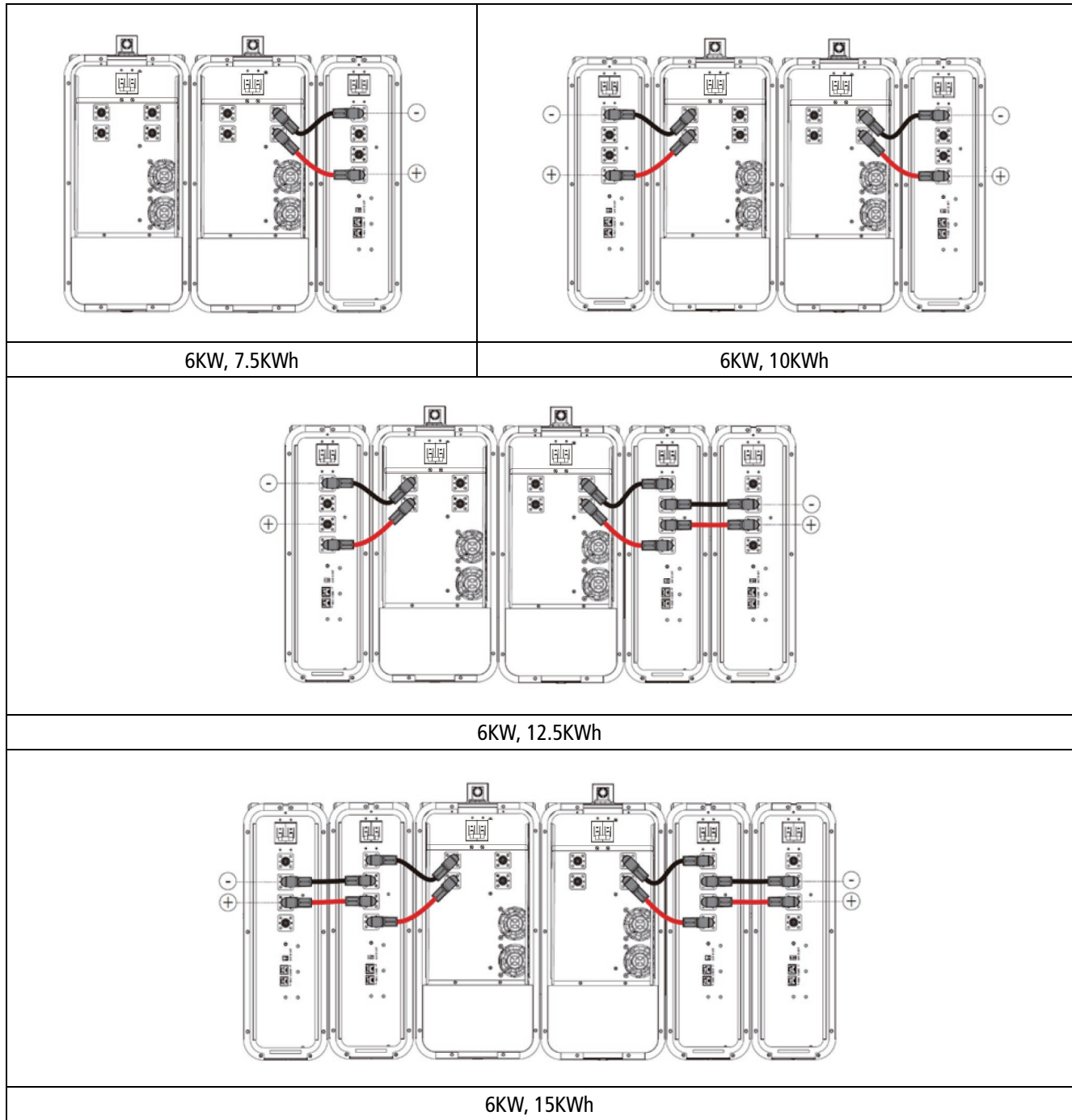

NOTICE: Common battery is not available.

Step 2: Connect extension port on the battery modules with RJ11 cables (supplied in the external battery module). After wiring installation is complete, set up the ID for each battery module. The ID code for each battery module **MUST** be unique. Commencing from EBM nearest to the UPS is designated number 0, the next EBM is designated number 1.

NOTE: ID Switch indicates the unique ID code for each battery module. It's required to assign a unique ID (0 or 1) to each battery module for normal operation.

Expanded Battery Capacity (BMS Cable)

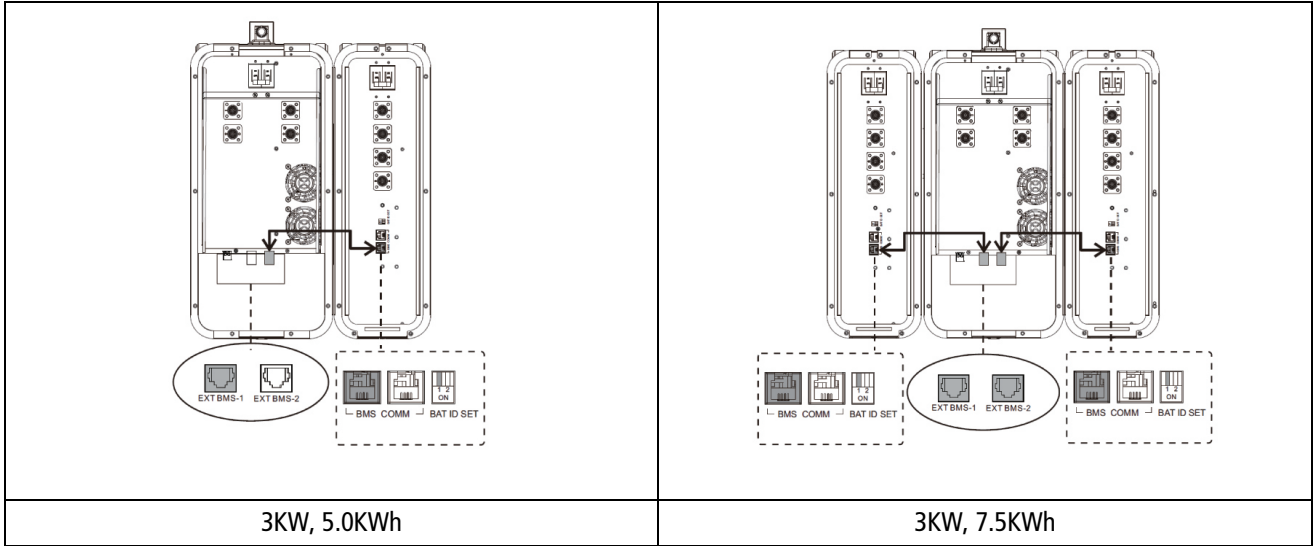

3KW, 5.0KWh

3KW, 7.5KWh

Paralleled UPS and Expanded Battery Capacity (BMS Cable)

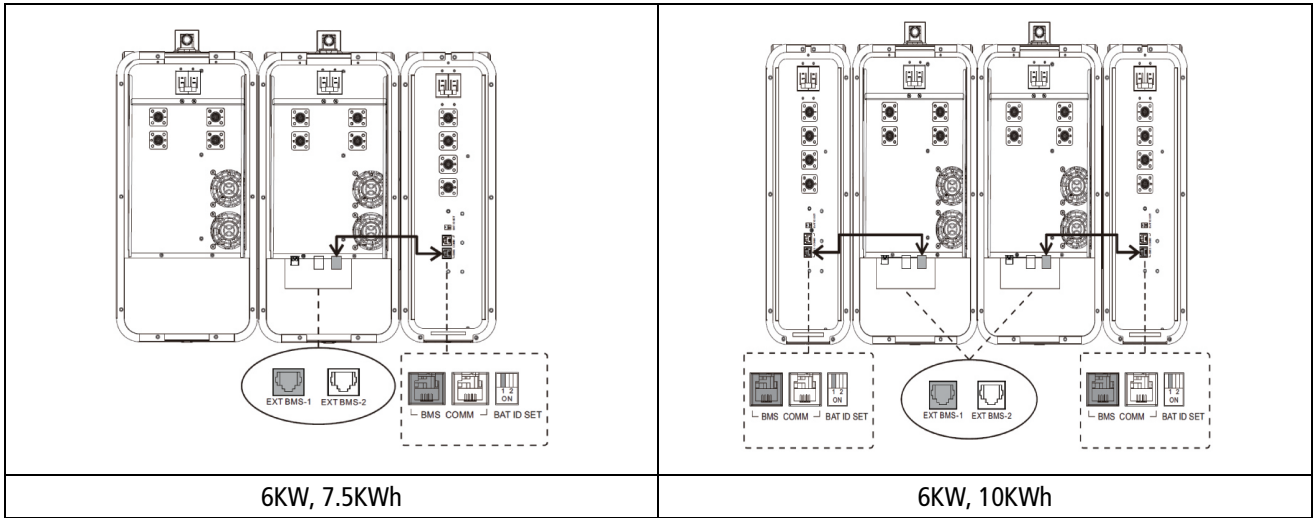

6KW, 7.5KWh

6KW, 10KWh

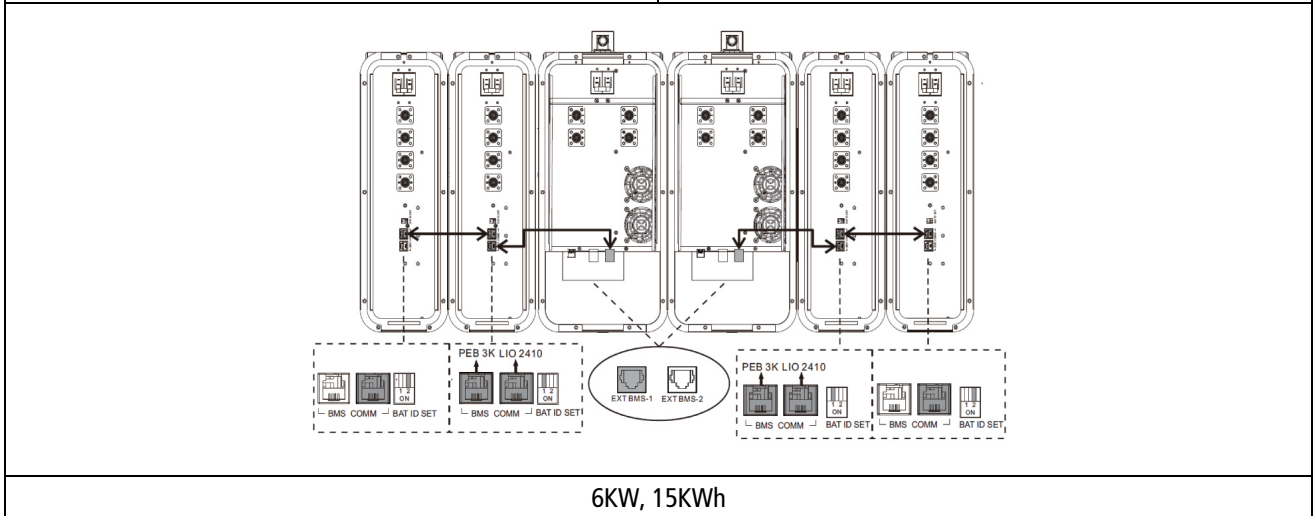

6KW, 15KWh

Step 3: Use the side cover to secure the PrimusCharge 3000 Battery Bank to the PrimusCharge 3000. See illustration below.

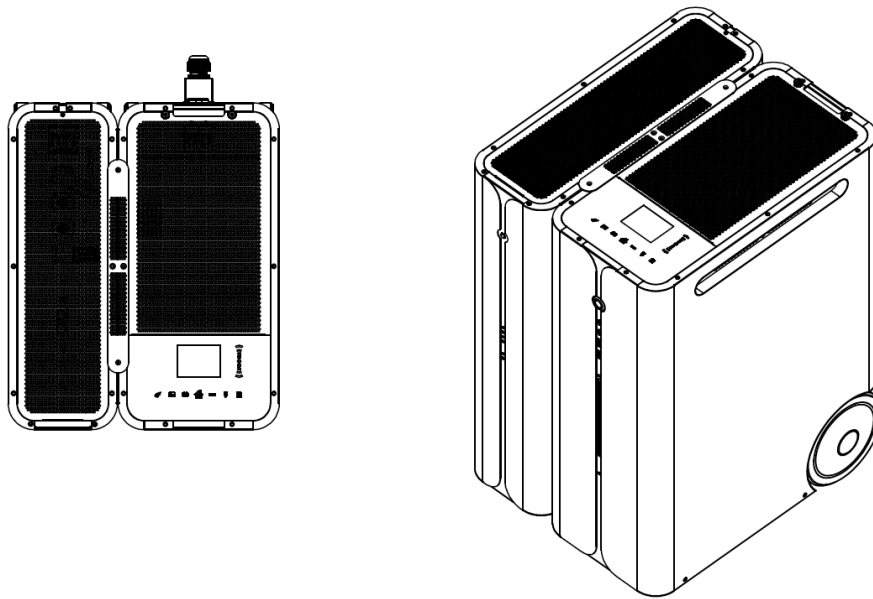

4.7.5 AC Output Connection

Open the parallel port cover and use one parallel cable (purchased separately) to connect the parallel ports on the two main units. Once the paralleled units are powered on, the user can connect load devices on either Master or Slave outlets.

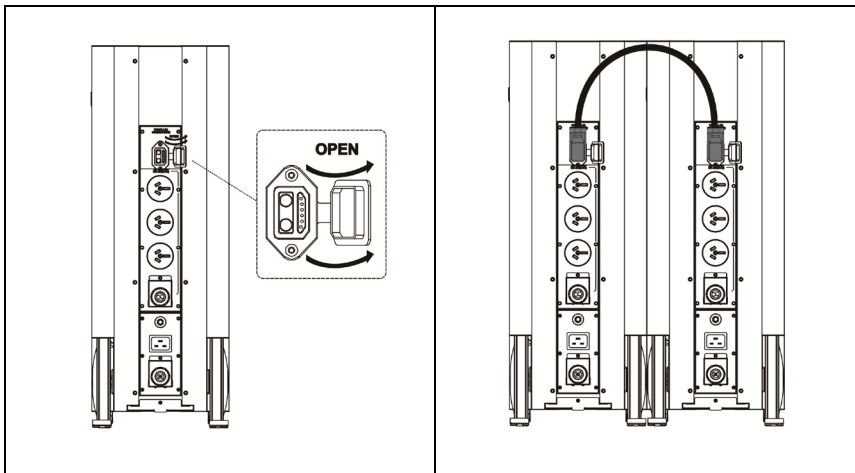

When the parallel system is operating, the LCD information on Master and Slave will present as below.

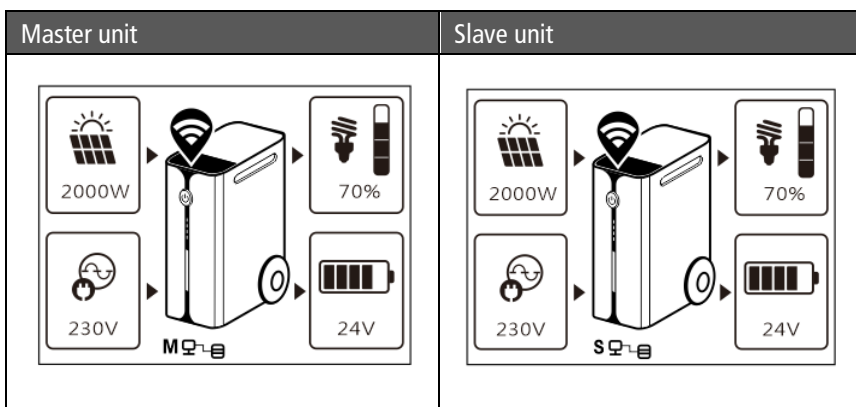

5. OPERATION

The unit is equipped with rechargeable Lithium batteries. Charge the battery for at least 12 hours before initial use. To calibrate the battery capacity, it is recommended to fully charge and discharge the batteries twice.

For long-term storage, it's recommended to discharge the battery to between 50% - 60% SOC, disconnect the internal DC breaker and store it in a cool, dry place.

5.1 Power ON/OFF



Once the unit has been properly installed and the batteries are connected correctly, simply press and hold the power button for 2-3 seconds until the UPS beeps then release the power button to turn on the unit.





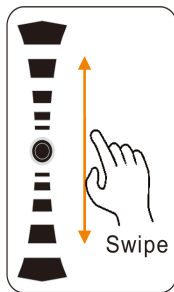
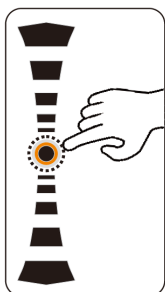
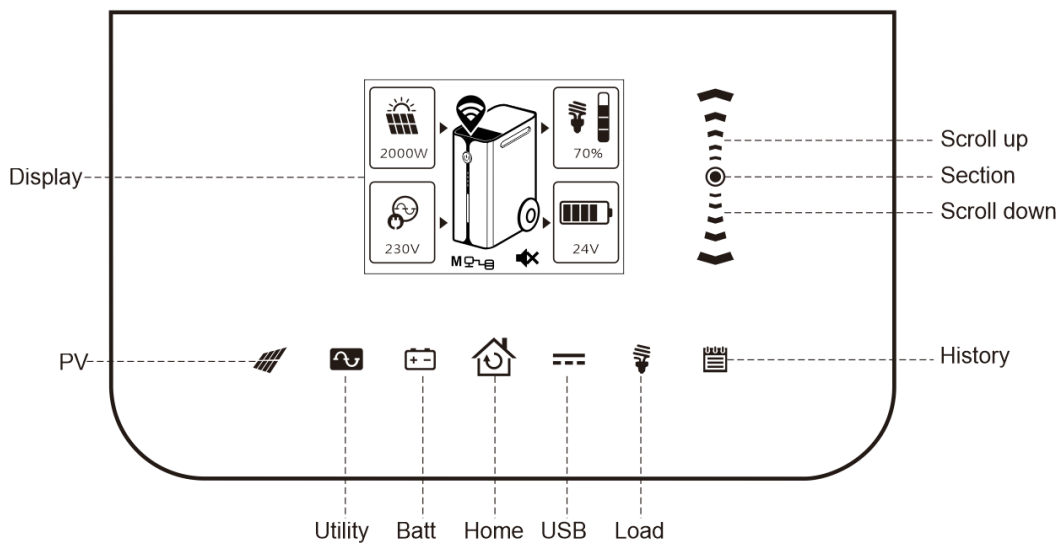







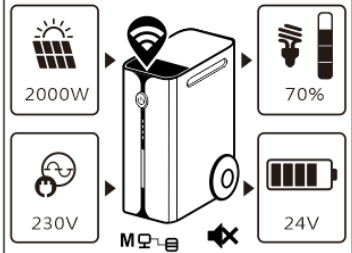
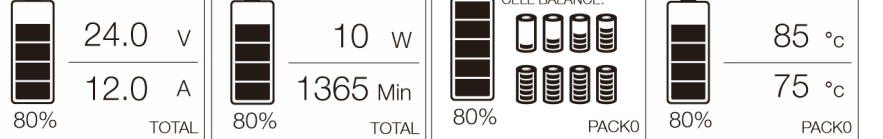































5.2 Operation and Display Panel

The operation and display panel, shown in the figure below, is located on the top of the unit. It includes a full colour LCD display, scrollbar and graphic touch pads, indicating the operating status and input/output power information.



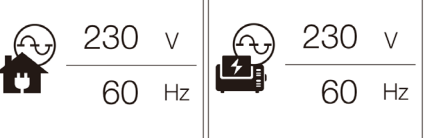
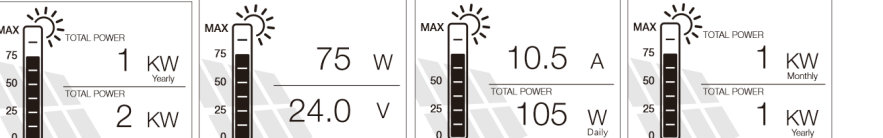
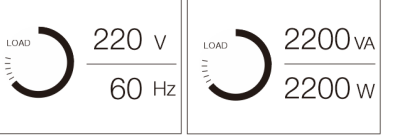

5.3 Page Information

When the unit is turned on, the LCD display will show home page after few seconds.

<p>Home page: (tap  icon 0.5s) indicates the summarized power flow and energy information.</p> 																													
<p>Battery page: indicates the battery cell and pack information.</p>																													
<p>Cell indication in battery page:</p>																													
<table border="1"> <tr> <td></td> <td></td> <td></td> <td></td> <td></td> <td></td> <td></td> </tr> <tr> <td>Cell >= 3.7V</td> <td>3.7V > Cell >= 3.45V</td> <td>3.45V > Cell >= 3.2V</td> <td>3.2V > Cell >= 3.0V</td> <td>3.0V > Cell >= 2.7V</td> <td>2.7V > Cell >= 2.5V</td> <td>Cell < 2.5V</td> </tr> <tr> <td></td> <td></td> <td></td> <td></td> <td></td> <td></td> <td></td> </tr> <tr> <td>SOC 100%</td> <td>SOC 80%</td> <td>SOC 60%</td> <td>SOC 40%</td> <td>SOC 20%</td> <td>SOC 0%</td> <td></td> </tr> </table>									Cell >= 3.7V	3.7V > Cell >= 3.45V	3.45V > Cell >= 3.2V	3.2V > Cell >= 3.0V	3.0V > Cell >= 2.7V	2.7V > Cell >= 2.5V	Cell < 2.5V								SOC 100%	SOC 80%	SOC 60%	SOC 40%	SOC 20%	SOC 0%	
																													
Cell >= 3.7V	3.7V > Cell >= 3.45V	3.45V > Cell >= 3.2V	3.2V > Cell >= 3.0V	3.0V > Cell >= 2.7V	2.7V > Cell >= 2.5V	Cell < 2.5V																							
																													
SOC 100%	SOC 80%	SOC 60%	SOC 40%	SOC 20%	SOC 0%																								
<p>AC input page: indicates the AC input source type and information.</p>																													
<p>PV page: indicates the PV information.</p>																													
<p>AC output page: indicates the AC output information.</p>																													
<p>USB charger page: real-time control on the output of USB charger ports.</p>																													
<p>Logs page: indicates all event, warning, and fault messages.</p>	<p>10-10, 18:30 W01 Grid not exist 1/15</p>																												

5.4 Configurations

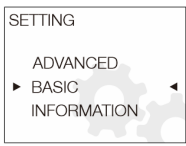
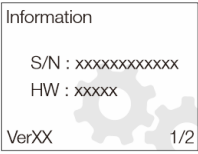
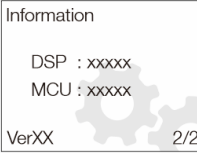
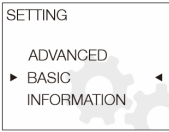
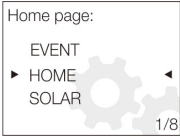
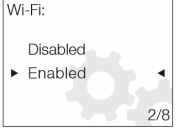
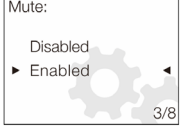
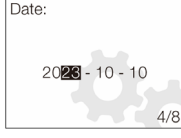
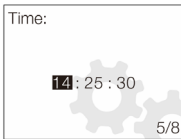
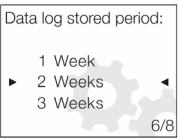
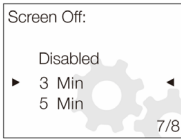
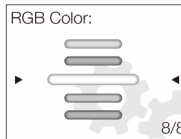
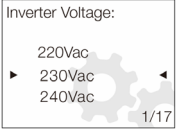
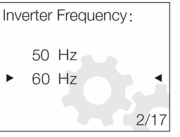
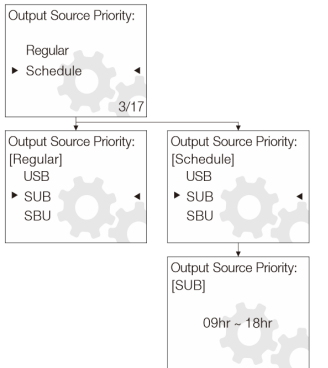
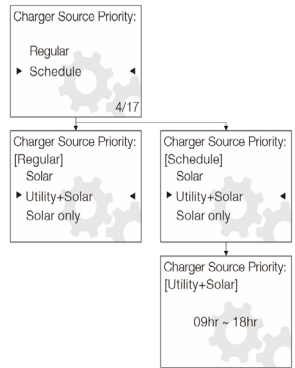
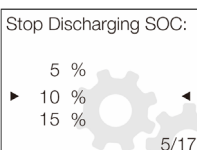
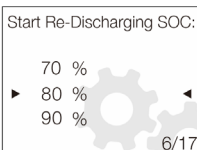
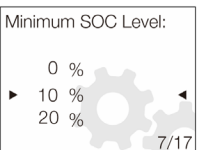
<p>Press  icon for 3s to enter the setting menu. There are three sub-menus: Information, Basic and Advanced.</p> <p>Click  icon again to exit setting return Home page.</p>			
<h3>Information</h3>			
			
<h3>Basic</h3>			
<h4>Change the main page</h4> 			
<h4>Setup home page</h4> 	<h4>Turn on/off Wi-Fi module</h4> 	<h4>Turn on/off buzzer</h4> 	<h4>Setup date</h4> 
<h4>Setup time</h4> 	<h4>Setup log record duration</h4> 	<h4>Enable screen off timer</h4> 	<h4>Change RGB LED colour</h4> 
<h3>Advanced</h3>			
<h4>Configure the nominal voltage and frequency</h4> <p>Default: 230Vac, 50Hz</p>			
<h4>Configure the output and charger source priority</h4> <p>Regular: Priority arranged per day Schedule: Priority arranged per hours</p> <p>Default: Regular</p>			
<h4>Configure the stop and restart discharging capacity and minimum SOC</h4> <p>Default: 10%, 80%, 10%</p>			

Configurations: Advanced, <i>Continued</i>	
Configure the maximum charging current and limitation while charging from Utility Default: 50A, 30A	<div style="display: flex; justify-content: space-around;"> <div style="border: 1px solid gray; padding: 5px; width: 45%;"> Charging Speed: Super charge, 100A ▶ Fast, 50A ◀ Normal, 30A 8/17 </div> <div style="border: 1px solid gray; padding: 5px; width: 45%;"> Utility Charging Speed: Trickle, 10A ▶ Normal, 30A ◀ Fast, 50A 9/17 </div> </div>
Configure the limitation of discharging current Default: Disabled (means no limited) **Parallel application will disable the discharging limitation	<div style="border: 1px solid gray; padding: 5px;"> Max. Discharging Current: Disabled ▶ 30 A ◀ 40 A 10/17 </div>
Configure the compatibility of AC input source Default: Utility	<div style="border: 1px solid gray; padding: 5px;"> AC Input Source: Utility ▶ Generator ◀ 11/17 </div>
Configure fault or overload behaviours Default: Disabled, Disabled	<div style="display: flex; justify-content: space-around;"> <div style="border: 1px solid gray; padding: 5px; width: 45%;"> Fault Auto-restart: Disabled ▶ Enabled ◀ 12/17 </div> <div style="border: 1px solid gray; padding: 5px; width: 45%;"> Overload Bypass: Disabled ▶ Enabled ◀ 13/17 </div> </div>
Specific critical operations (Password 4743 is necessary) Reset to factory setting Erase all logs Export all logs Firmware upgrade	<div style="display: grid; grid-template-columns: repeat(4, 1fr); gap: 5px;"> <div style="border: 1px solid gray; padding: 5px; width: 25%;"> Erase all data log: Password 0000 14/17 </div> <div style="border: 1px solid gray; padding: 5px; width: 25%;"> Reset to default: Password 0000 15/17 </div> <div style="border: 1px solid gray; padding: 5px; width: 25%;"> Firmware Upgrade: Password 0000 16/17 </div> <div style="border: 1px solid gray; padding: 5px; width: 25%;"> Export Logs: Password 0000 17/17 </div> <div style="border: 1px solid gray; padding: 5px; width: 25%;"> Erase all data log: Reset ▶ Not reset ◀ 14/17 </div> <div style="border: 1px solid gray; padding: 5px; width: 25%;"> Reset to default: Disabled ▶ Enabled ◀ 15/17 </div> <div style="border: 1px solid gray; padding: 5px; width: 25%;"> Firmware Upgrade: YES ▶ NO ◀ 16/17 </div> <div style="border: 1px solid gray; padding: 5px; width: 25%;"> Export Logs: YES ▶ NO ◀ 17/17 </div> </div> <div style="border: 1px solid gray; padding: 5px; margin-top: 5px;"> Invalid password, try again </div> <div style="display: grid; grid-template-columns: repeat(4, 1fr); gap: 5px;"> <div style="border: 1px solid gray; padding: 5px; width: 25%;"> Erase all data log: Invalid! 0000 14/17 </div> <div style="border: 1px solid gray; padding: 5px; width: 25%;"> Reset to default: Invalid! 0000 15/17 </div> <div style="border: 1px solid gray; padding: 5px; width: 25%;"> Firmware Upgrade: Invalid! 0000 16/17 </div> <div style="border: 1px solid gray; padding: 5px; width: 25%;"> Export Logs: Invalid! 0000 17/17 </div> </div>

5.5 Wi-Fi Connection

This unit is equipped with a Wi-Fi transmitter. The Wi-Fi transmitter can enable wireless communication between the PrimusCharge 3000 and monitoring platform. Users can access and control the monitored UPS with a downloadable APP.

Once the Wi-Fi connection is made, the Wi-Fi icon will be displayed on the LCD.

For quick installation and operation, please refer to Appendix I - The Wi-Fi Operation Guide for details.

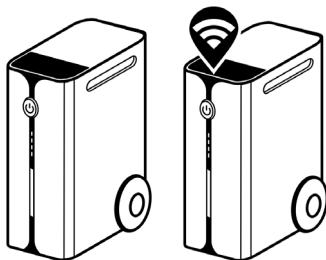

5.6 Prioritising Energies Scenarios

(Note: the following demonstrations do not include and calculate the real conversion efficiency of the unit.)

A. Load supplied from Solar firstly then Battery and Utility.

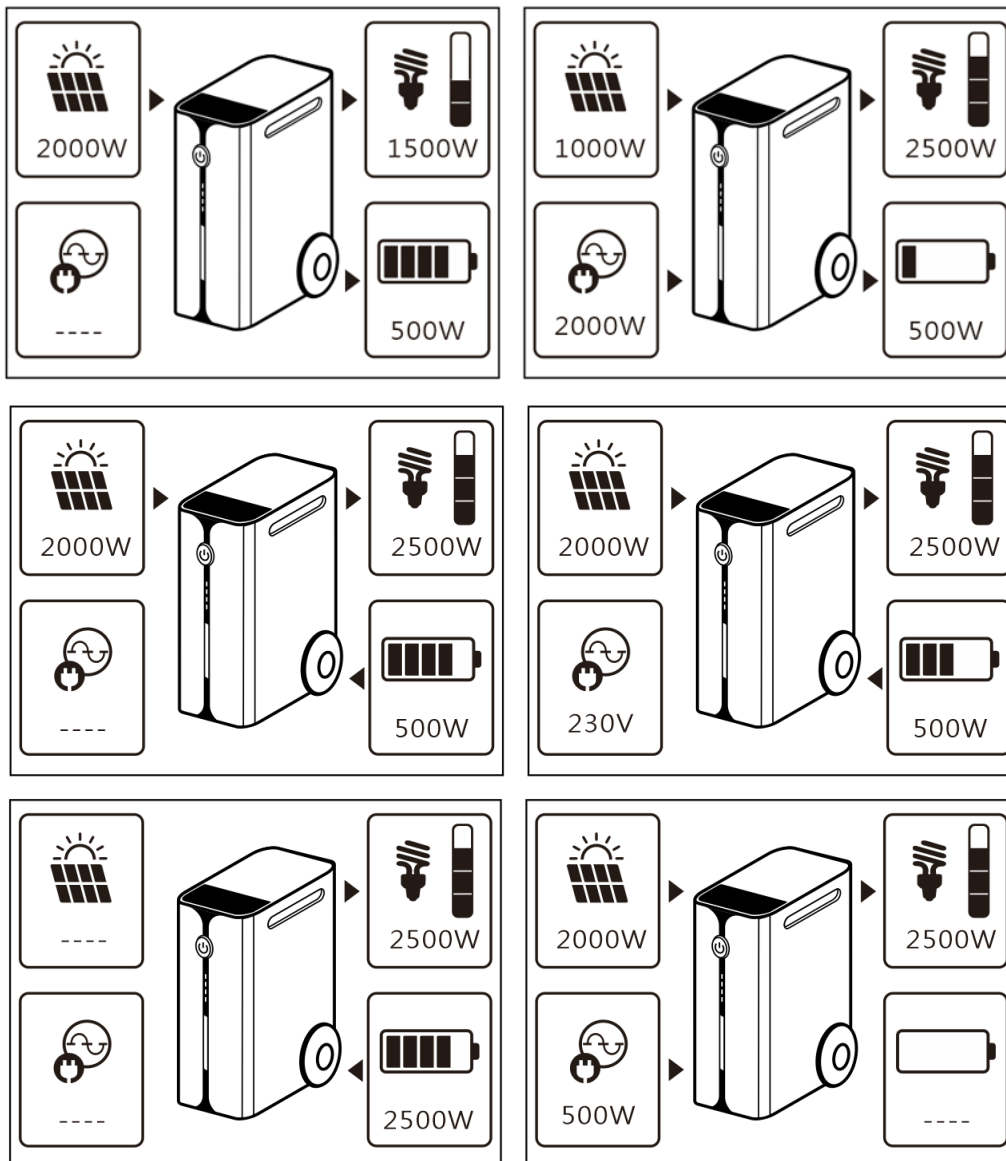
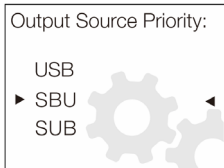

Prioritising Energies Scenarios *Continued*

B. Load supplied from Solar firstly then Utility and Battery

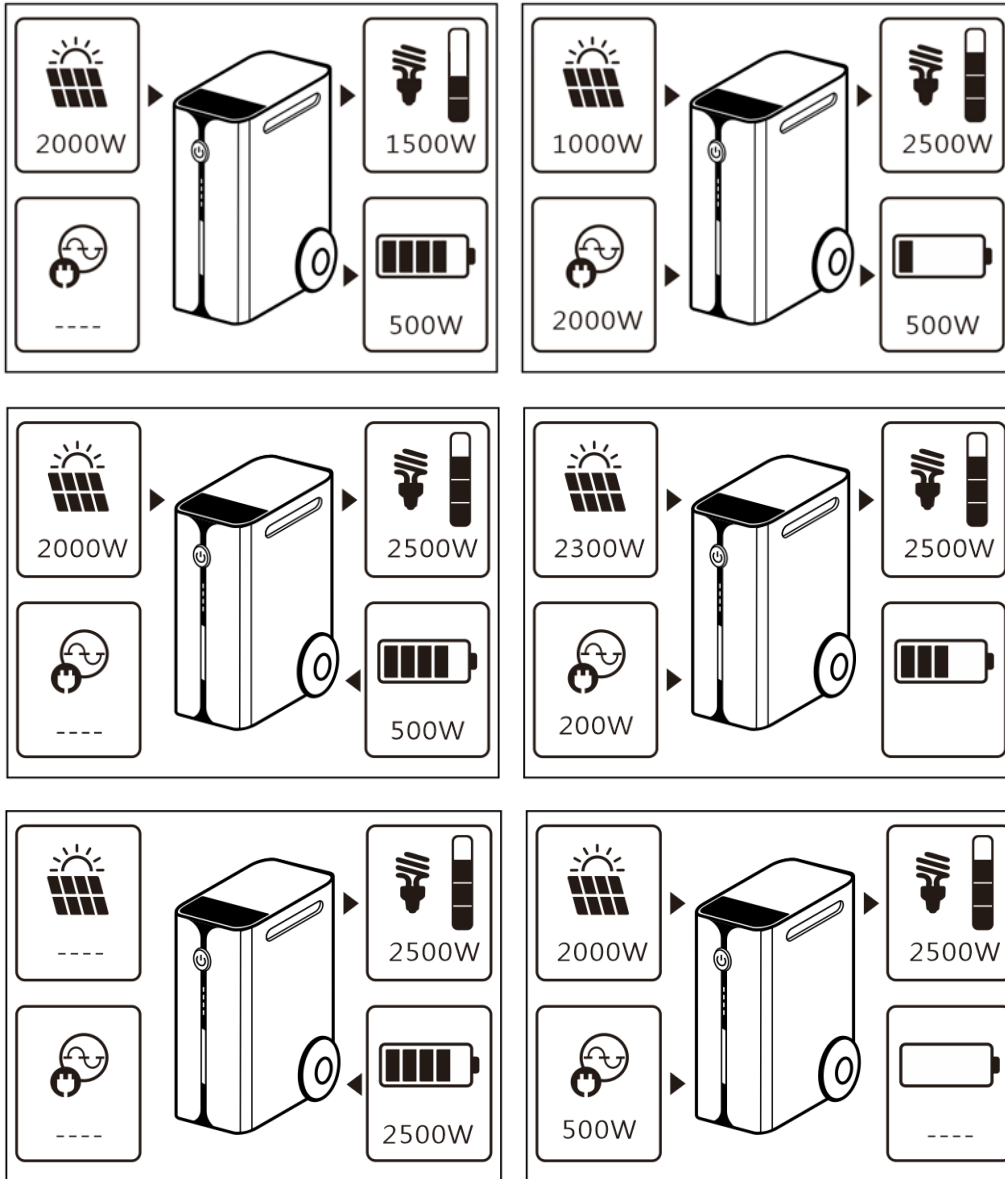
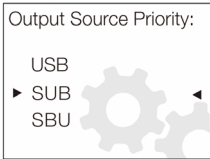

Prioritising Energies Scenarios *Continued*

C. Load supplied from Utility firstly then Solar and Battery

Output Source Priority:

- SBU
- ▶ USB
- SUB

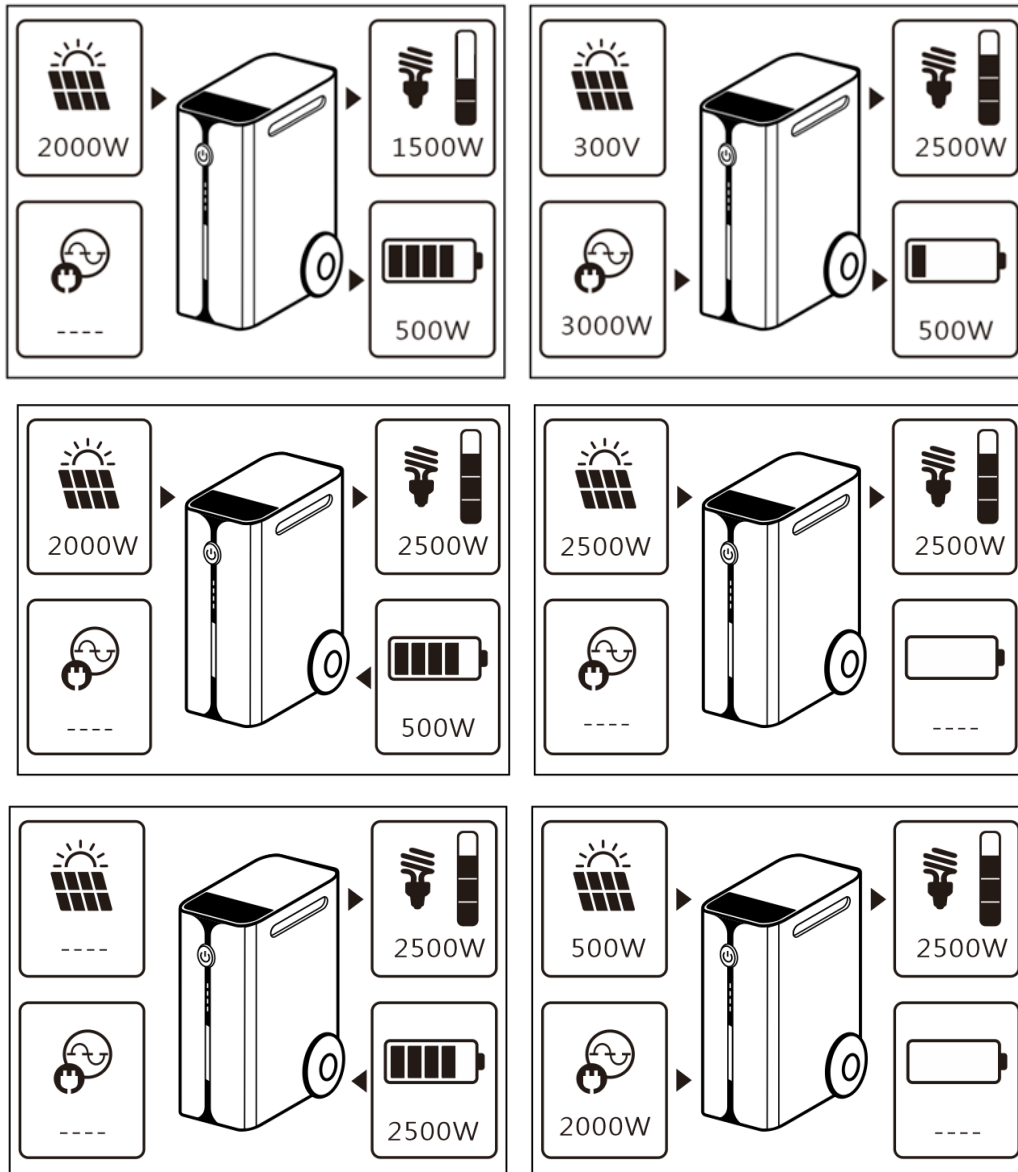

6. STORAGE AND MAINTENANCE

6.1 Storage

Before storing, charge the UPS. For optimal results charge to 50-60% SOC.

Store the UPS covered and upright in a cool, dry location.

Storage		
SOC	50-60 %	(optimal)
Temperature	10-35C	-10C – 40C (Maximum)
Relative Humidity	0-95%	Non-condensing
Every six (6) months	Charge the battery to 60% SOC	
Every twelve (12) months	Full discharge and charge to 60% SOC	

6.2 Maintenance

To maximize the longevity of the UPS, PowerShield highly recommends ongoing preventative maintenance.

Failure to maintain your assets may lead to the UPS not performing as expected. PowerShield recommends the following:

6.2.1 Filter Maintenance (3 monthly)

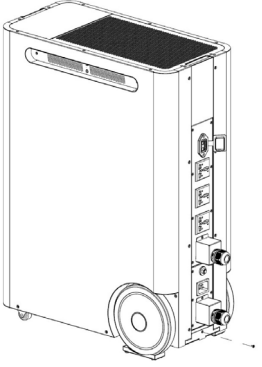
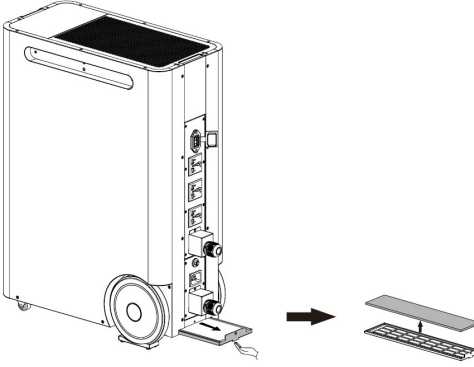
<p>Step 1: Please loosen the screw on the rear-panel as shown below.</p>	<p>Step 2: Then, slide the filter panel forward and then the filter medium can be removed.</p>	<p>Step 3: Clean the filter medium, re-assemble the filter kit and then replace in the unit.</p>
		<p>NOTICE: PowerShield recommends cleaning the air filter every three (3) months.</p>

6.2.2 Visual Inspection (3 monthly)

- Concurrently with the filter maintenance.
- Visual Inspection of UPS, batteries, battery terminals, solar panels (if installed) and cabling.
- Confirm UPS if free of any fault codes.

6.2.3 System Testing (Yearly)

At the same time as the filter Maintenance as outlined above.

- Once a year confirm the operation of the UPS.
- Remove mains, confirm PV holds the load (if installed).
- Remove Mains, remove PV, confirm UPS runs on battery.
- Reinststate PV.
- Reinststate Mains.
- Confirm no fault codes.

7. RUNTIME TABLE

LOAD	%	25	50.0	75.0	100.0
	W	750	1500	2250	3000
Internal Battery	hrs	3.1	1.5	1.0	0.8
+ 1 EBM	hrs	6.1	3.1	2.0	1.5
+ 2 EBM	hrs	9.2	4.6	3.1	2.3

8. TROUBLE SHOOTING

8.1 Warning and Fault List

Code Type	Code #	Event	Code Type	Code #	Event
Fault	F01	Fan fault	Fault	F15	Bus start fault
Fault	F02	High PV-volt	Fault	F16	Inv start fault
Fault	F03	High bat-volt	Fault	F17	High dc offset
Fault	F04	Low bat-volt	Fault	F18	Over-load
Fault	F05	Output S.C.	Fault	F19	Amp sense fault
Fault	F06	High op-volt	Fault	F20	Backfeed fault
Fault	F07	Low op-volt	Fault	F21	Firmware fault
Fault	F08	High bus-volt	Fault	F22	Par-CAN fault
Fault	F09	Low bus-volt	Fault	F23	Par-host fault
Fault	F10	High PV-amp	Fault	F24	Par-sync fault
Fault	F11	High inv-amp	Fault	F25	Par-bat fault
Fault	F12	High bus-amp	Fault	F26	Par-grid fault
Fault	F13	High disc-amp	Fault	F27	Par-opa fault
Fault	F14	Over temp.	Fault	F28	Par-set fault
Warning	W01	Grid not exist	Warning	W07	Over-load
Warning	W02	PV not exist	Warning	W08	Temp issue
Warning	W03	Pack not exist	Warning	W09	Fan issue
Warning	W04	Weak SoC	Warning	W10	BMS lost
Warning	W05	Weak PV-volt	Warning	W11	Comm. Lost
Warning	W06	Power de-rate	Warning	W12	Par limited

Alarm displayed	What to do
No response while pressing the main switch.	
No Utility power and PV has been applied.	Check whether the DC breaker tripped or has not yet turned on? If problem persists, please contact the service centre.
No response while pressing the main switch.	
Utility power or PV power has been applied.	Check whether the AC breaker has tripped. Check if PV voltage is within 60VDC ~ 400VDC If problem persists, please contact the service centre.
Output turned off, Buzzer beeps continuously, RED LED continuously on	
F01 Fans abnormally stopped during startup sequence	Please contact service centre to replace them.
F02 PV overvoltage	Configure the PV panels for lower than 450V.
F03 High battery voltage	Disconnect the Utility and PV power. Then, re-apply both again. If over-voltage alarm persists, please contact the service centre.
F04 Battery voltage dropped to an extremely low level	Please contact the service centre.
F05 Load short circuit	Check and verify if the load has a short circuit. Remove the load and restart the unit again. If problem persist, please contact the service centre.
F14 Over temperature	Clean the anti-dust filter and ensure the unit installed in a temperature-controlled environment.
F18 UPS over-load	Reduce the applied load and restart the unit again.
F21 Firmware fault	New firmware not compatible with the unit, please contact service centre.
F06, F07, F08, F09, F10, F11, F12, F13, F15, F16, F17, F19 or F20	Please restart the unit again. If problem persists, please contact the service centre.
F22, F23, F24, F25, F26, F27 or F28	Please check if the parallel cable is connected. Restart the units. If problem persists, please contact the service centre.
Output powered but buzzer beeps once per second, RED LED flashing	
W04 Low battery voltage	Charge the battery.
W05 Low PV voltage	Reduce the load.
W06 Low utility voltage	The output will be de-rated.
W07 Over-load	Reduce the load to clear the warning.
W08 Over-temperature	Clean the anti-dust filter and ensure the unit installed in a temperature-controlled environment.
W09 Fan fault.	Please contact service centre to replace them.
W10 BMS fault.	Please contact service centre.
W11 Comms fault.	Please contact service centre
WiFi icon is not displayed on LCD	
Unit can't connect to the APP.	Check the Wi-Fi function enabled on UPS. Check that the icon is available on the LCD. Follow the Wi-Fi installation procedure to pair the Wi-Fi module with router and APP.
USB ports not charging.	
No power from the USB charger ports.	Check whether the USB charger function is enabled.
Parallel units cannot be started up successfully	
W12 Paralleling fault.	CAUTION: Parallel feature will be disabled when only PV power is available, and batteries are not available.

9. APPENDIX I: THE WI-FI OPERATION GUIDE

1. Introduction

The Wi-Fi module can enable wireless communication between inverter and monitoring platform. Users can remote monitor and control the UPS using the i.Solar APP.

The major functions of the i.Solar APP include:

- Device status
- Device configuration
- Warning and alarm notifications
- Access to UPS history data.

2 i.Solar App

2.1 Download and install APP

Use the QR code below to download and install "i.Solar" app to your mobile phone.



(iOS)



(Android)

2.2 Initial Setup

- Turn on the unit.
- Open the Wi-Fi settings from your smart phone.
- Connect your smart phone to the Wi-Fi module. The Wi-Fi named starts with "FC41D_".
- Default password for the Wi-Fi module is: 12345678

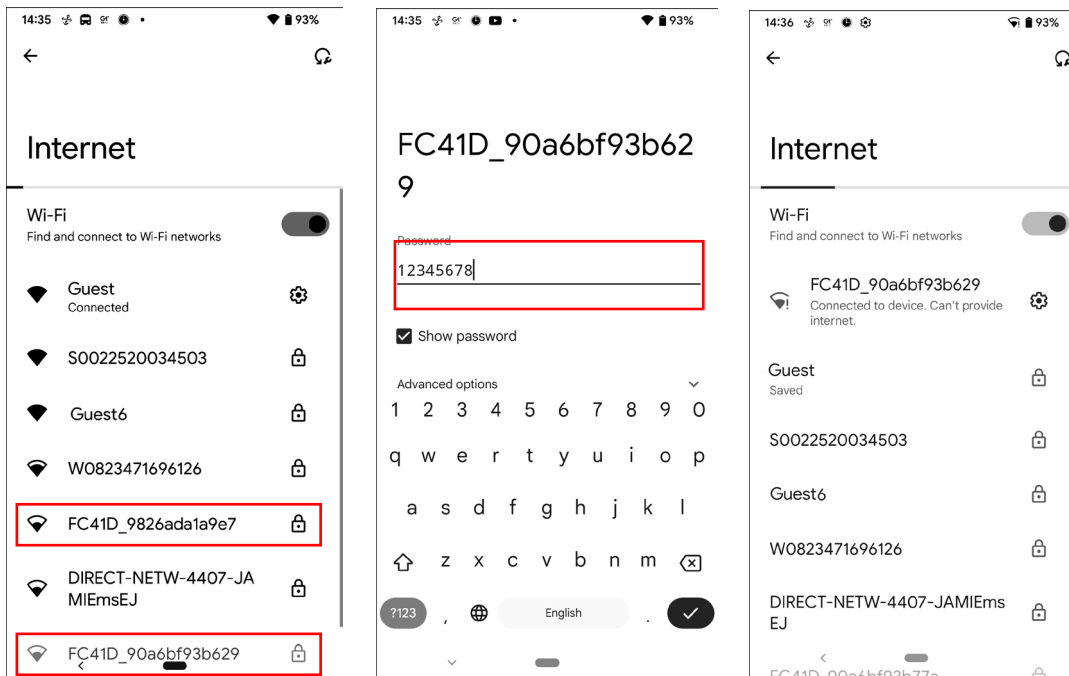

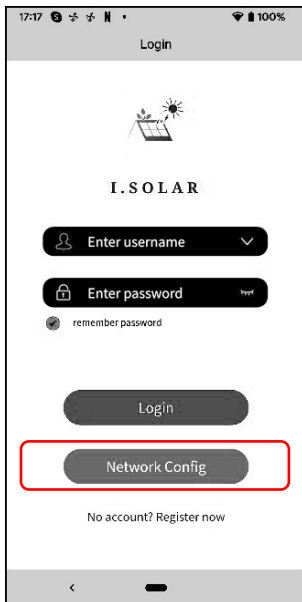

- Once the Wi-Fi connection is successful, click the i.Solar App installed on the phone to enter the login page. Then click the "Network Config" button to enter the Wi-Fi configuration page.

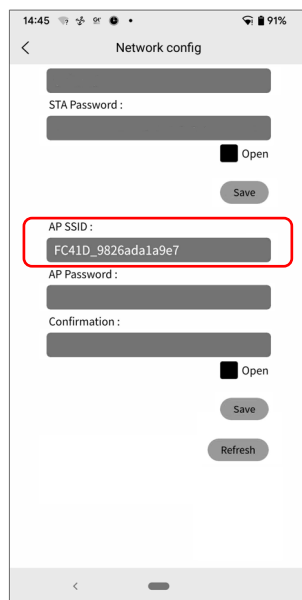

- The configuration page of the "Network Config" is shown as following.

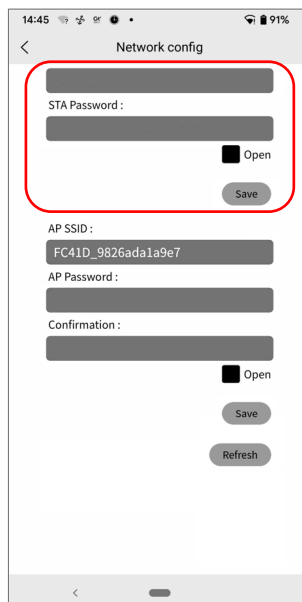

- Enter your router Wi-Fi name and password, then click the "Save" button to complete the setting.
If you check "Open" checkbox, you only need to enter the Wi-Fi name, password is not required.
Then, click the "Save" button to complete the setting.
The Wi-Fi module is only compatible with **2.4GHz** Wi-Fi.

- After completing the configuration, remove the Wi-Fi module from your smartphone to prevent automatic reconnection, which may disrupt internet access.

2.3 Log-In

- Connect your smart phone to the Wi-Fi.
- Registration.

Enter username and password and click the "Register" button to complete the user registration. Once registration is complete, click "Click to log in" or return to the previous page (click the left arrow to return to the login page).

Then, enter the registered username and password to log in.

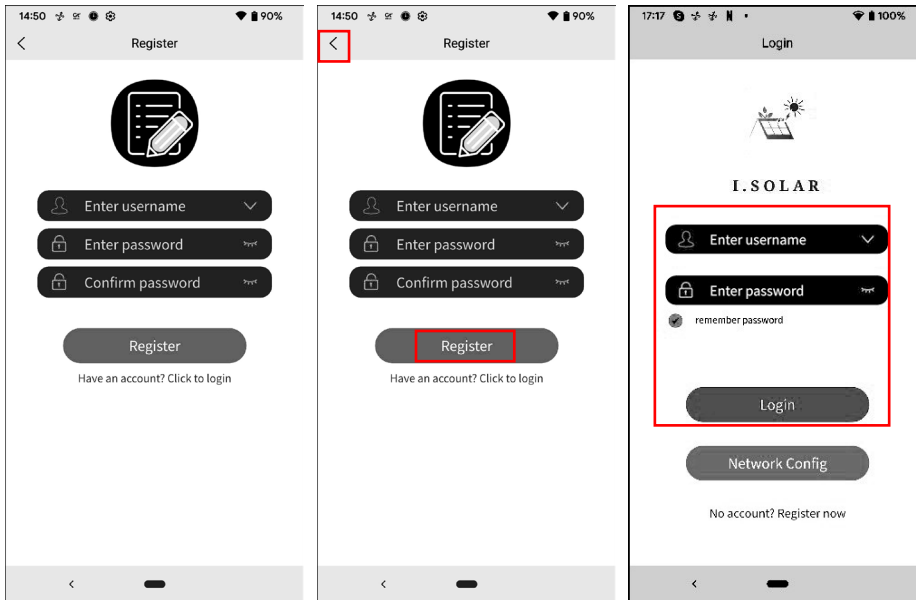

2.4 Home Page

- After login, the default Home page will appear. Please be patient as it may take time to synchronize the App and the UPS.
- Tap the icon (located on the right top) to enter the page to add, delete or rename the device.
- Input the device serial number to add the device.

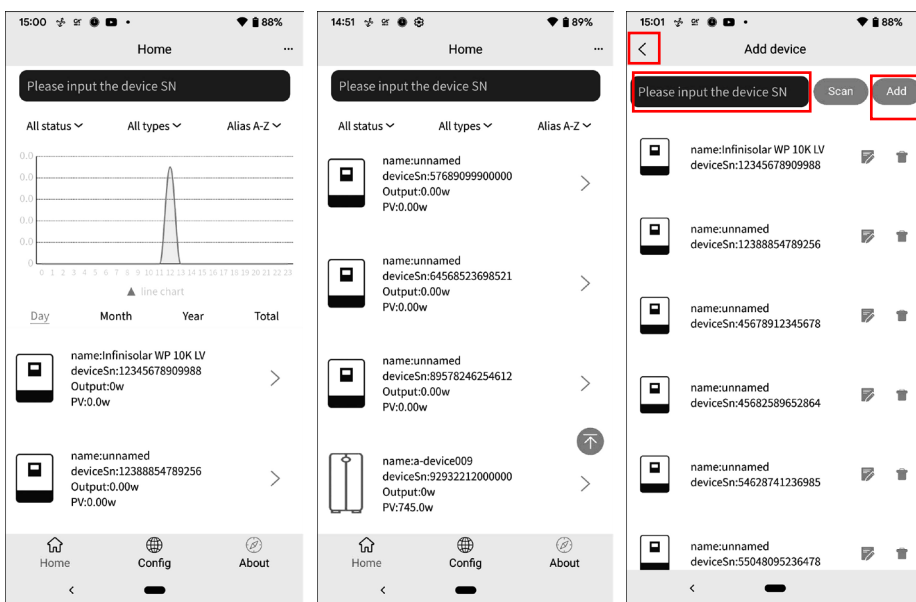

- Rename or delete the device

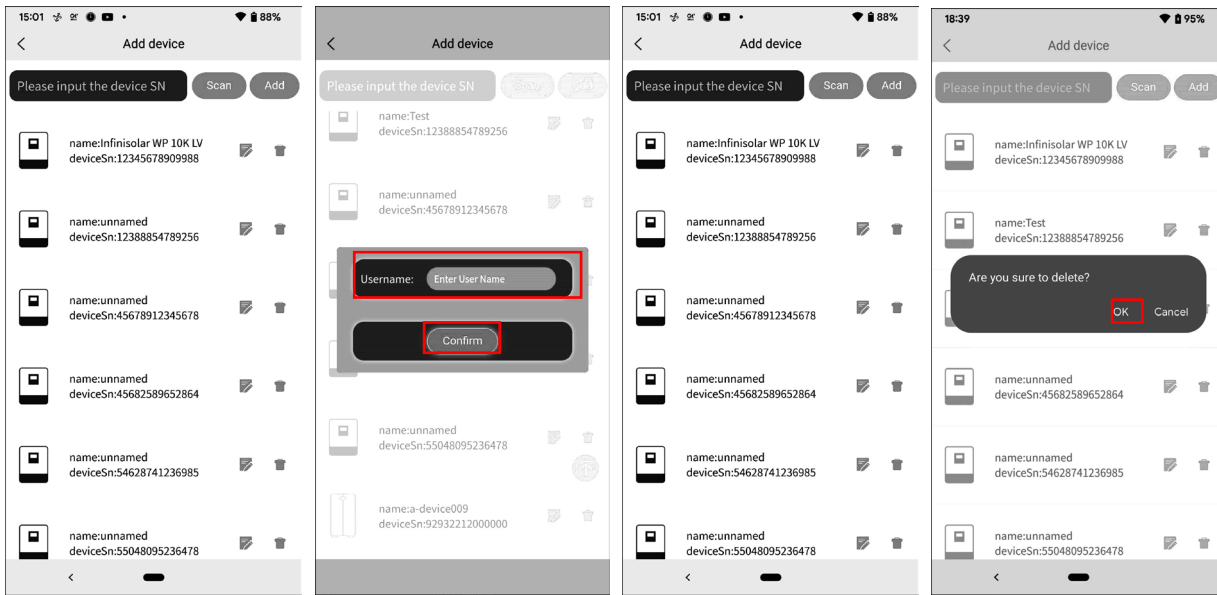

- Chart data area:
 - Day:** Click the button to query the hourly power generation data of the current day.
 - Month:** Click the button to query the daily power generation data of the current month.
 - Year:** Click the button to query the monthly power generation data of the current year.
 - Total:** Click the button to query the annual power generation data.

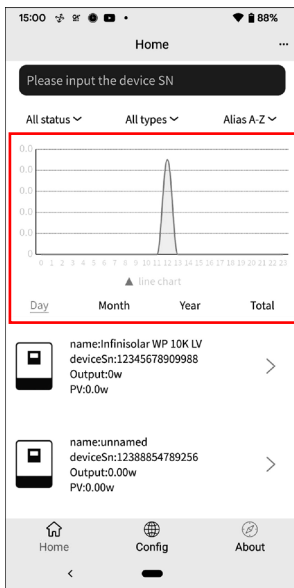

2.5 Real-time data

- Main page displays battery information, including SOC, battery temperature, battery voltage, charge or discharge power, charge or discharge current, backup time, battery cell temperature and voltage, grid power, solar power generation in day, month, year, total, and AC output power consumption in day, month, year, total.

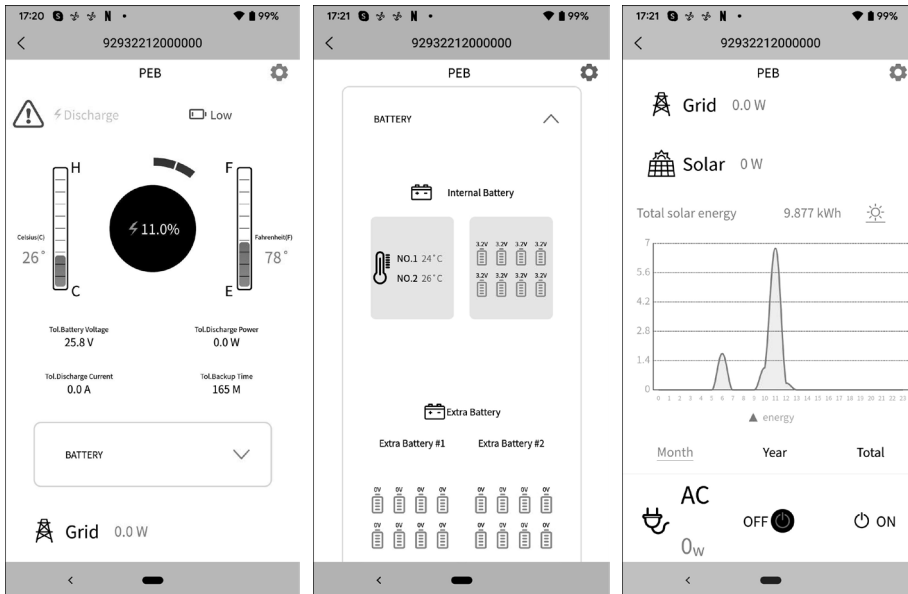

- Remote control power on/off and USB charger on/off.

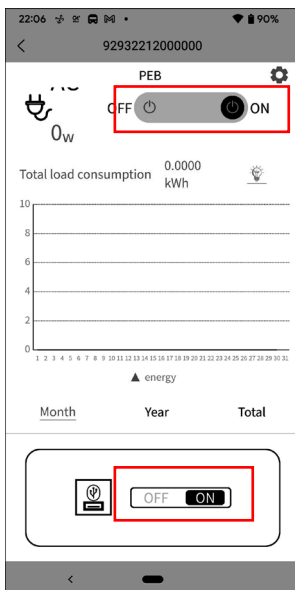

- Tap the icon (located on the right top) to enter the setting page.

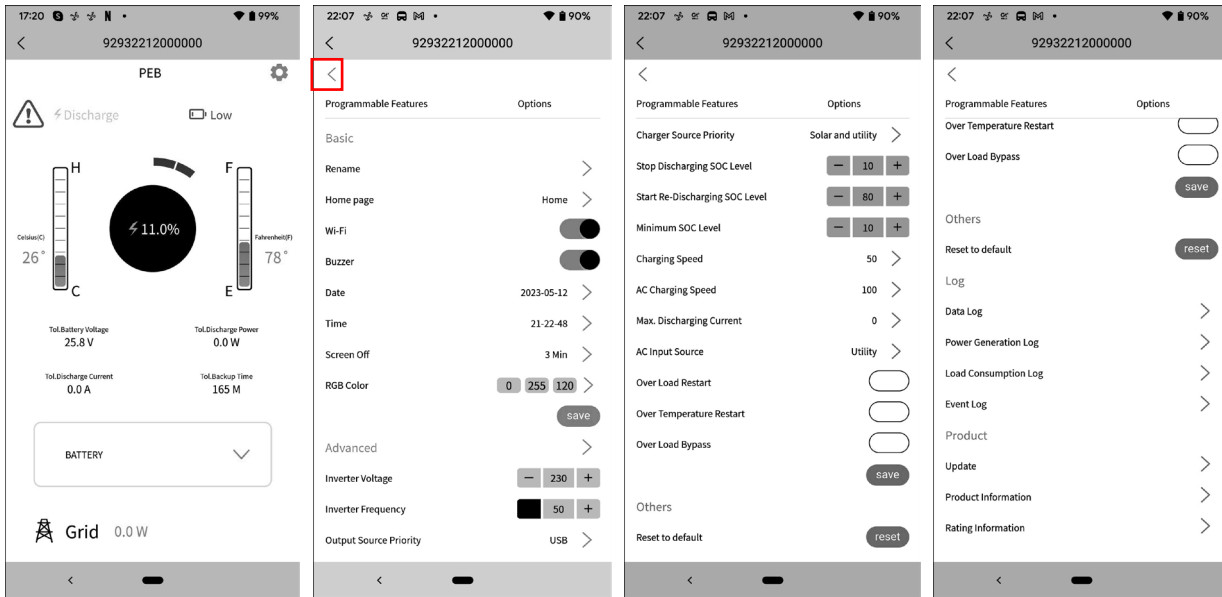

- “Basic” and “Advanced”: displays the setting items. With different models, the setting items on the parameter page will be different.
- Select the setting and click the “Save” button to change the setting.

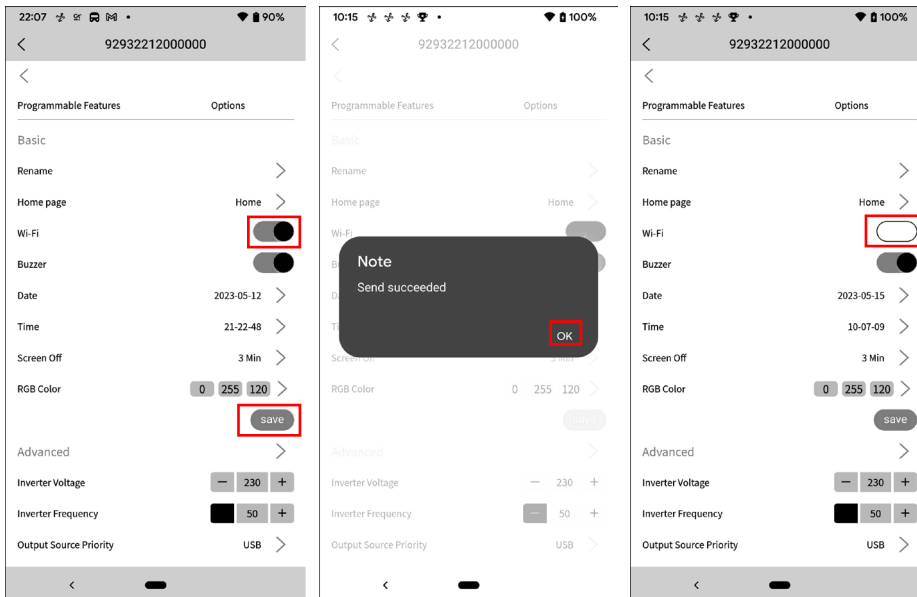

- If “Please make settings” is displayed, it means that the setting is the same and there is no need to set it again.

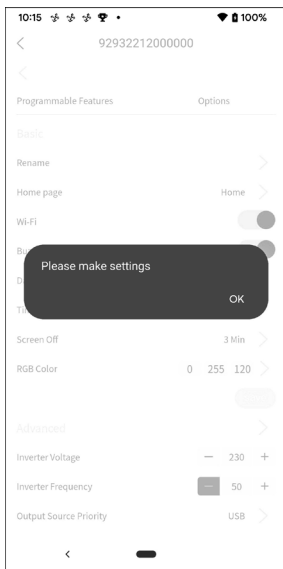

- Rename the device.

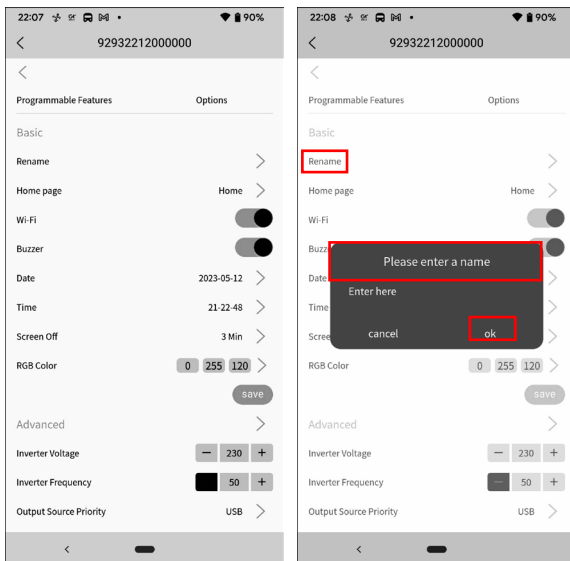

- **Log:** displays data log, solar power generation log, load consumption log and event.
Data log: Tap the time, select the date and click the “Browse” button to update log.

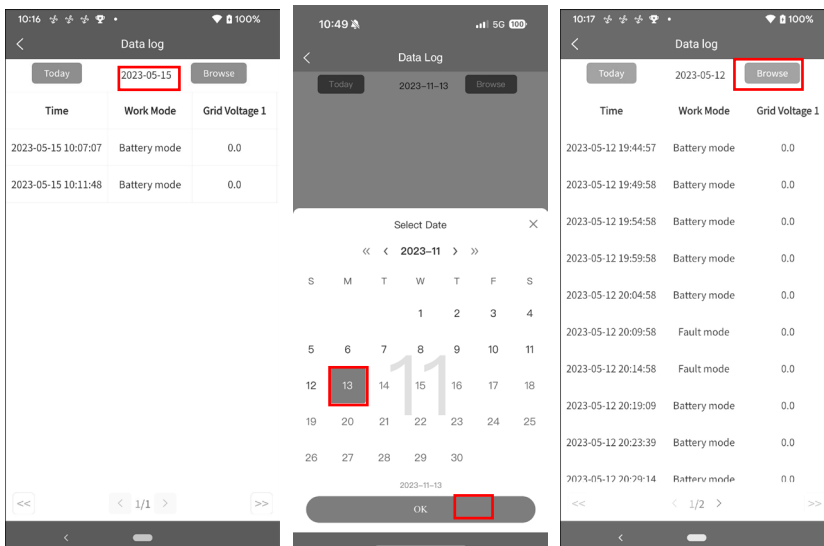

- **Power Generation Log and Load Consumption Log:** Tap the time, select the day, month or year, and click the "Done" button to update log.

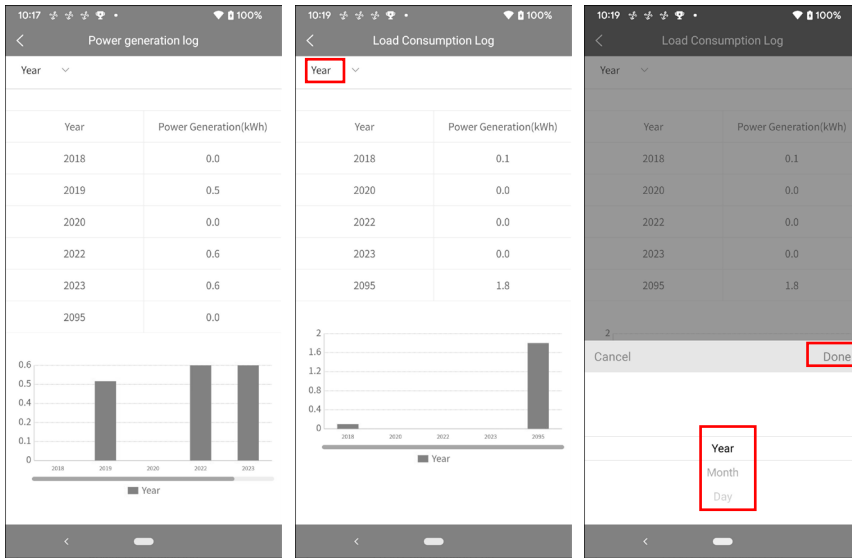

- **Event log:** Tap the time, select the month and click the "Browse" button to update log.

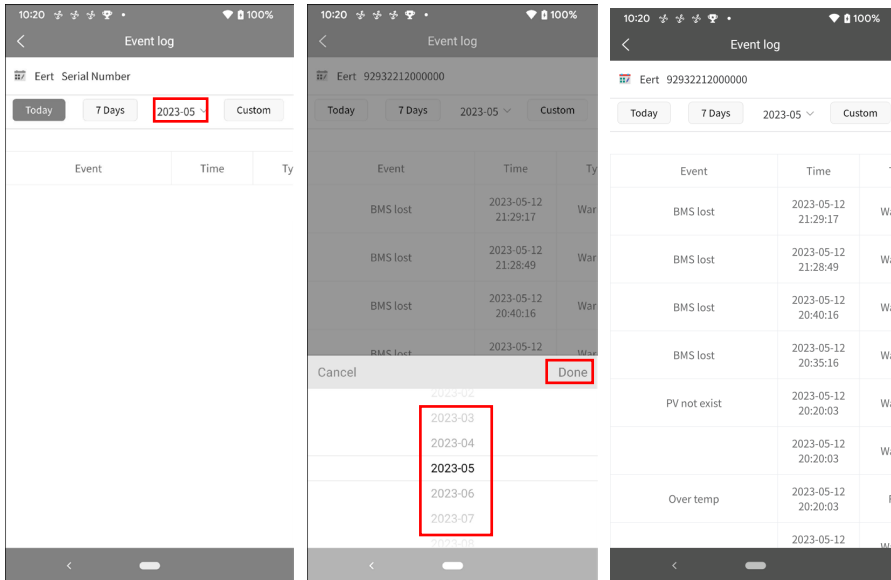

- **Product:** displays update status, product information and rating information.

Update Apply: Please contact Powershield for any firmware updates.

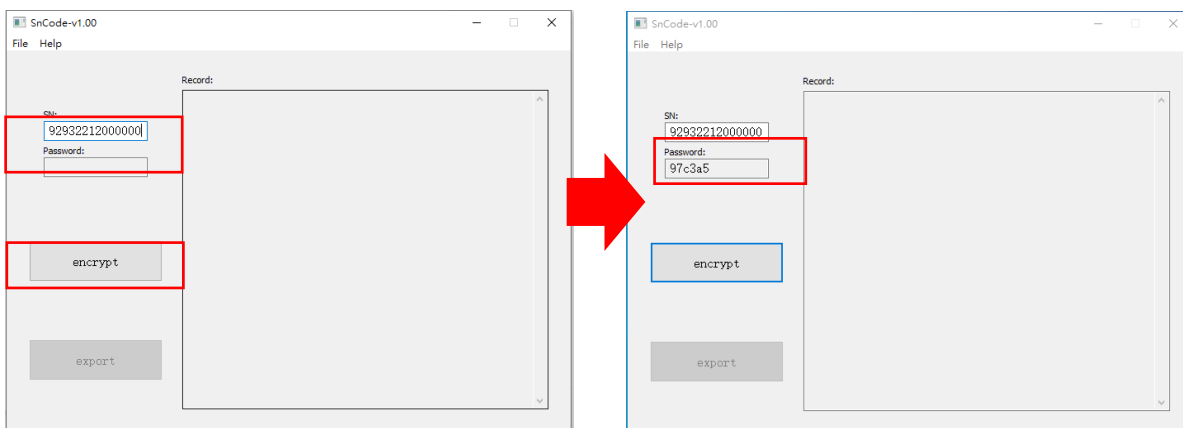

- Click "Apply", select CPU type and input updated password.

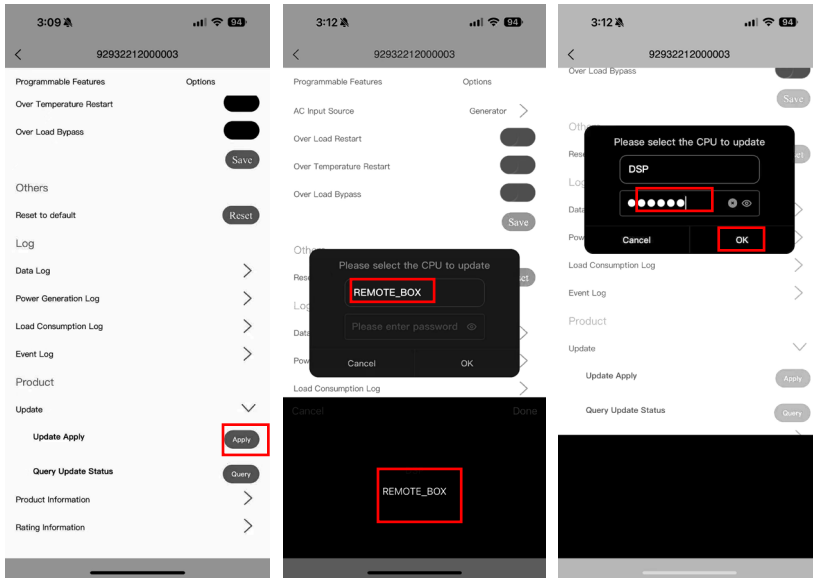

- Query Update Status:

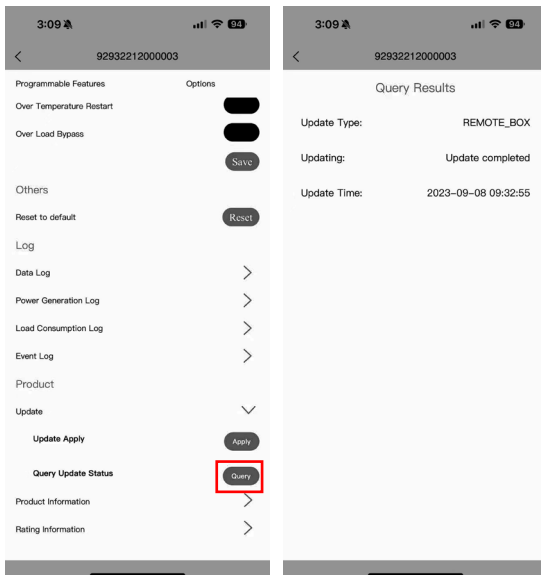

- Product information and rating information

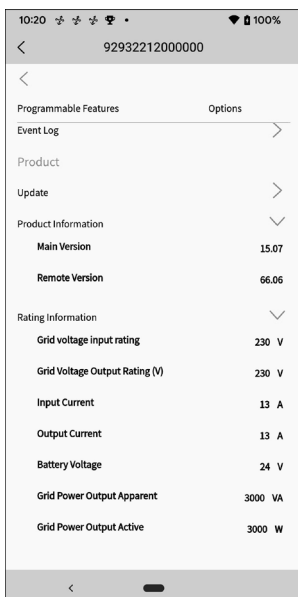

2.6 Configuration

- Change password, delete account, network config, language setting and remove account.

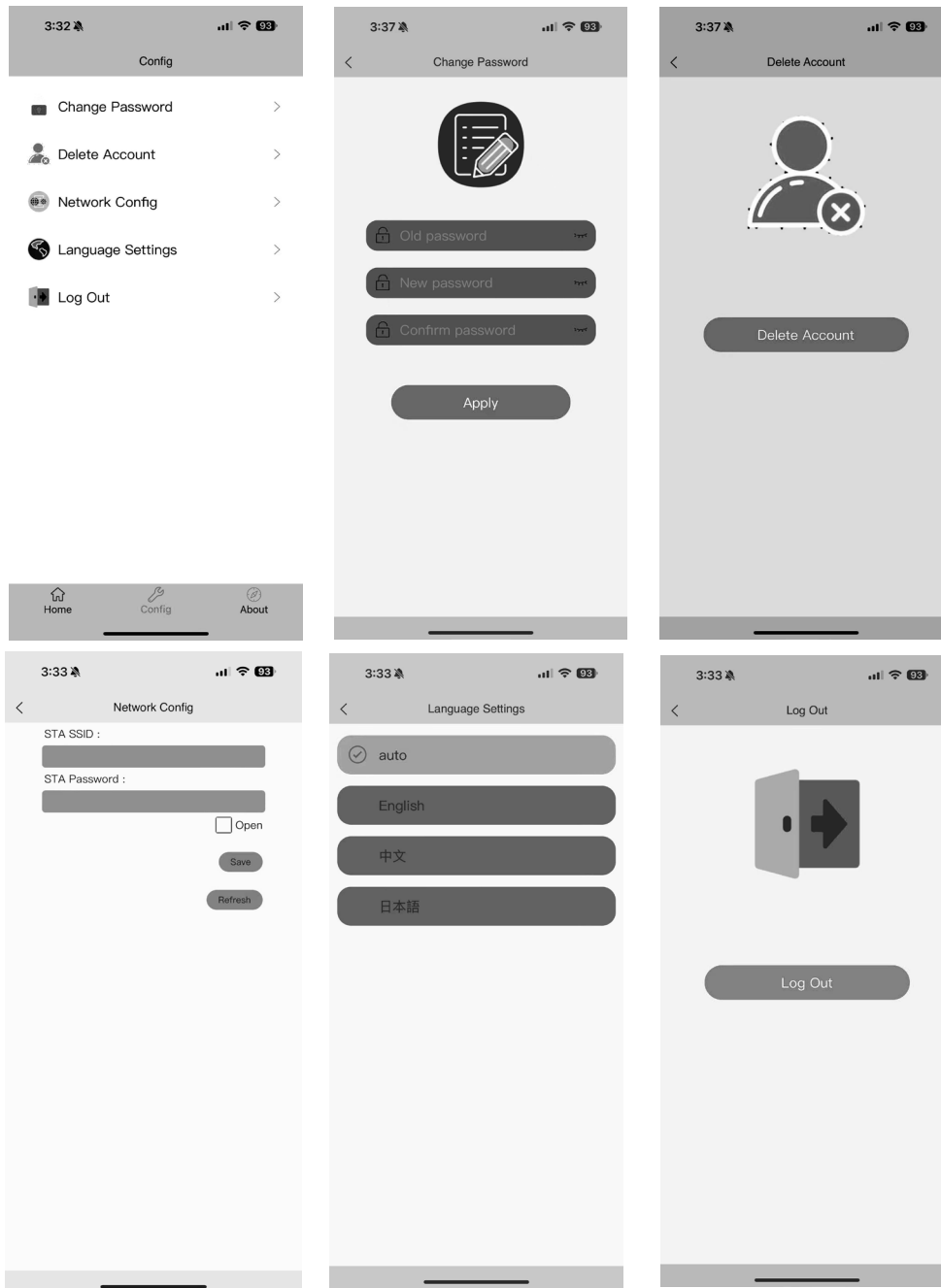

2.7 About

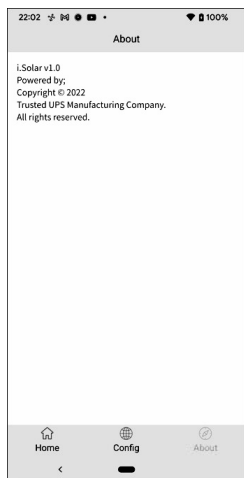

10. SPECIFICATIONS – PRIMUSCHARGE 3000

Rated Inverter Power	3000VA / 3000W	
Part Number	PSPC3000	
INPUT		
Voltage	220 / 230 / 240VAC	
Selectable Voltage Range	170VAC ~ 280VAC (Utility)	90VAC ~ 280VAC (Generator)
Frequency Range	50 Hz/60 Hz (Auto sensing)	
Max. Current and Protection	20A, Circuit breaker built-in	
OUTPUT		
AC Voltage Regulation (Batt. Mode)	220 / 230 / 240VAC ± 5%	
Surge Power	6000VA	
Efficiency (Peak)	93%	
Transfer Time	15ms ~ 20ms	
Waveform	Pure Sine Wave	
Frequency	50 Hz/	
USB CHARGER		
USB-A	2 x 18W (5V @3A, 9V @2A)	
USB-C PD 3.0 compliant	2 x 65W (5V @3A, 9V @2A, 20V @3.25A)	
SOLAR & AC CHARGER		
Solar Charger type	MPPT	
Maximum PV Power	3000W	
MPPT Range @ Operating Voltage	60VDC ~ 400VDC	
Maximum PV Open Circuit Voltage	450VDC	
Maximum Charge Current	100A	
BATTERY MODULE		
Capacity	2500Wh	
Nominal Voltage	25.6 VDC	
Full Charge Voltage	28.2 VDC	
Full Discharge Voltage	20.0 VDC	
Max. Discharging Current	200A	
Protection	BMS, Breaker	
Internal Resistance	≤0.6 mΩ	
Lifecycle	≥3500 cycles, 0.5C charging/discharging ≥80% @EOL 100% DoD	
INTERFACE		
Function Keys	Touch PAD	
Display	Full Colour LCD + RGB LED	
Communication	Wi-Fi	
PHYSICAL		
Dimension, D X W X H (mm)	450 x 222 x 620	
Net Weight (kgs)	42	
IP Rating	21	
STANDARD		
Compliance Safety	IEC/EN 62109-1/-2, EN 61000-6-4, EN-61000-6-2 IEC 62619, UN38.3	

11. SPECIFICATIONS – PRIMUSCHARGE BATTERY BANK

Part Number	PSPCBB100
Capacity	2500Wh
Nominal Voltage	25.6 VDC
Full Charge Voltage	28.2 VDC
Full Discharge Voltage	20.0 VDC
Max. Discharging Current	120A
Protection	BMS, Breaker
Internal Resistance	≤0.6 mΩ
Lifecycle	≥3500 cycles, 0.5C charging/discharging ≥80% @EOL 100% DoD
PHYSICAL	
Dimension, D X W X H (mm)	450 x 150 x 620
Net Weight (kgs)	25
IP Rating	21
STANDARD	
Compliance Safety	IEC/EN 62109-1/-2, EN 61000-6-4, EN-61000-6-2 IEC 62619, UN38.3

PowerShield®



For more information, please visit
www.powershield.com.au or phone 1300 305 303